

CREATING POWER SOLUTIONS.

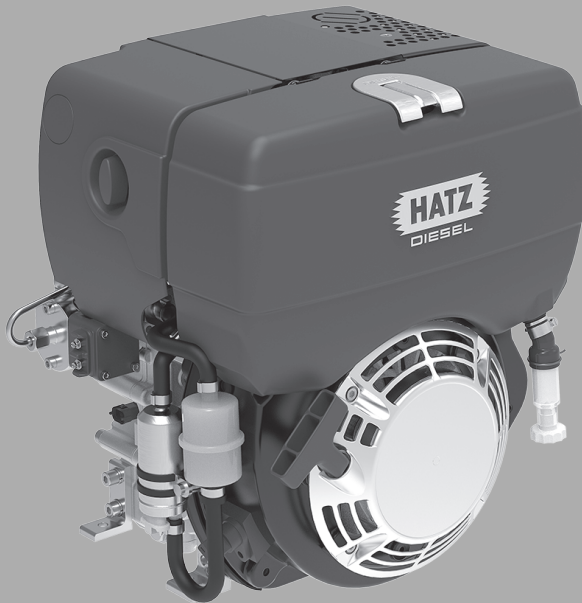

INCLUDES SUPPLEMENTAL INFORMATION TO THE OWNER'S MANUAL FOR MODEL YEAR 2024 FOR EPA AND CALIFORNIA CERTIFIED NONROAD COMPRESSION IGNITION ENGINES.

1B30E | 1B50E

OPERATOR'S MANUAL

Diesel engine

Hatz Diesel

www.hatz-diesel.com

1	Legal notices	5
2	General information	6
3	Safety	7
3.1	General information.....	7
3.1.1	Intended use.....	7
3.1.2	Machine user or machine manufacturer obligations.....	8
3.1.3	Representation of safety notes.....	9
3.1.4	Meaning of safety symbols.....	10
3.2	Safety notes.....	12
3.2.1	Operational safety.....	12
3.2.2	Machine-specific safety instructions for operation.....	15
3.2.3	Machine-specific safety instructions for maintenance work.....	16
3.2.4	Electrical equipment.....	18
3.3	Labels.....	20
4	Technical data	21
4.1	Engine information and filling quantities.....	21
4.2	Engine type plate.....	23
4.2.1	Engine serial number.....	24
4.3	Engine oil.....	25
4.4	Fuel.....	26
5	Engine overview	27
5.1	Designation of components.....	27
5.2	HATZ instrument box.....	30
6	Transport, installation and commissioning	33
6.1	Transport.....	33
6.2	Installation notes.....	34
6.3	Preparations for commissioning.....	35
6.4	Filling engine oil (first filling).....	36
6.5	Venting the fuel system.....	37
7	Operation and use	39
7.1	Safety notes.....	39
7.2	Performing tests.....	40
7.3	Starting the engine.....	40
7.4	Switching off the engine.....	43
7.5	Check the oil level.....	45
7.6	Refueling.....	47
7.7	Checking the water separator.....	49
7.8	Check the air filter warning indicator (option).....	51

8	Maintenance	52
8.1	General maintenance instructions.....	52
8.2	Maintenance work.....	53
8.2.1	Maintenance notice label	53
8.2.2	Maintenance plan.....	54
8.2.3	Checking the intake area	57
8.2.4	Change the engine oil	58
8.2.5	Clean the oil filter	61
8.2.6	Checking and setting the tappet clearance.....	64
8.2.7	Cleaning the cooling air area	66
8.2.8	Check the screw connections	69
8.2.9	Clean the exhaust screen	69
8.2.10	Changing the fuel filter	71
8.2.11	Maintaining the dry air filter.....	74
8.2.12	Checking and cleaning the air filter cartridge.....	76
9	Faults	78
9.1	Troubleshooting	78
9.2	Flash code table for engine faults	81
9.3	Emergency hand start.....	84
10	Storage and disposal	89
10.1	Storing the machine	89
10.2	Disposing of the machine.....	91
11	Proof of quality	92
12	EPA AND CARB CERTIFIED ENGINES	93
13	EPA CERTIFIED ENGINES WITHIN CALIFORNIA	100

1 Legal notices

Contact data

© 2023
Motorenfabrik Hatz
Ernst-Hatz-Straße 16
94099 Ruhstorf
Germany
Tel. +49 (0)8531 319-0
Fax +49 (0)8531 319-418
marketing@hatz-diesel.de
www.hatz-diesel.com
All rights reserved!

Copyright

The copyright for this manual rests entirely with Motorenfabrik HATZ, Ruhstorf.

This manual may only be copied or distributed if written approval has been received. This also applies to the copying or distribution of excerpts of this manual. The same conditions apply to distribution of this manual to third parties in digital form.

Original manual

This manual has been translated into multiple languages.

The German version is the **original manual**. All other language versions are **translations** of the **original manual**.

2 General information

Information on the document

This manual was created with due care. It is exclusively intended to offer a technical description of the machine and to provide instructions on commissioning, operating and maintaining the machine. When operating the machine, the applicable standards and legal regulations as well as any in-house regulations apply.

Before commissioning, during operation and before maintenance work is begun on the machine, read this manual carefully and keep it close by for ready access.

Machine

This manual describes the following machine.

Machine name	HATZ diesel engine
Type number	1B30E, 1B50E

Customer service

Have service work performed by qualified technicians only. We recommend that you work with one of the over 500 **HATZ service stations**. Trained specialists there will repair your machine with **Hatz original spare parts** and with **HATZ tools**. The global HATZ service network is at your disposal to advise you and supply you with spare parts. For the address of the **Hatz service station** nearest you, please see the enclosed spare parts list or visit us in the Internet at: **www.hatz-diesel.com**

Installation of unsuitable spare parts can lead to problems. We cannot accept liability for direct damage or secondary damage that results from this.

We therefore recommend the use of **Hatz original spare parts**. These parts are manufactured according to strict Hatz specifications and achieve maximum operational reliability through their perfect fit and functionality. The order number can be found in the enclosed spare parts list or on the Internet at: **www.hatz-diesel.com**

Exclusion of liability

The manufacturer cannot be held liable for personal injury, damage to property or damage to the machine itself caused by improper use, foreseeable misuse, or failure to follow or adequately follow the safety measures and procedures described in this manual. This also applies to changes made to the machine and the use of unsuitable spare parts.

Modifications, which serve the technical improvements, are reserved.

3 Safety

3.1 General information

Introduction

This chapter contains the information you need to work safely with this machine.

To prevent accidents and damage to the machine, it is imperative that these safety instructions be followed.

Read this chapter carefully before beginning work.

3.1.1 Intended use

Intended use

The machine described in this manual fulfills the following functions:

- Diesel engine intended for installation in a machine or for assembly with other machines to form a machine. See chapter *11 Proof of quality*, page 92.

This engine is intended exclusively for the purpose specified and tested by the manufacturer of the machine in which the engine is installed.

Any other use is not intended and therefore not permitted. Violations compromise the safety of the personnel working with the machine. Motorenfabrik HATZ does not accept any liability for damage resulting from this.

The operational safety of the machine is only guaranteed if it is used as intended.

The intended use also includes observance of the instructions in this Operator's Manual to preserve the environment, including in the appendix for the model year 2024 as per EPA Nonroad Diesel Engines and for the model year 2024 CARB-certified heavy-duty off-road engines.

Foreseeable misuse

The following is considered to be foreseeable misuse:

- Any use that varies from or extends beyond the uses specified above.
- Failure to comply with the instructions given in this manual.
- Failure to comply with the safety instructions.
- Failure to immediately eliminate malfunctions that impact safety before continuing work with the machine (working with the machine when it is not in perfect condition, either functionally or in terms of safety).
- Failure to perform the necessary inspection and maintenance work.
- Any unauthorized modification of or removal of safety equipment.
- Use of spare parts and accessories that are unsuitable or have not been approved by HATZ.
- Operation in flammable or hazardous environments.

- Operation in closed-off or poorly ventilated rooms.
- Operation in an aggressive atmosphere (e.g., high salt content) without further measures for corrosion protection.
- Installation of the machine on movable machines (e.g., vehicles, trailers) without HATZ approval.
- Improper operation at variance with DIN ISO 3046 -1 and DIN ISO 8528 (climate, load, safety).

Residual risks

Residual risks result during daily use and in association with maintenance work.

These residual risks will be pointed out in chapter 3.2.2 *Machine-specific safety instructions for operation, page 15* and in chapter 3.2.3 *Machine-specific safety instructions for maintenance work, page 16* as well as in the further contents of the manual, directly in front of the descriptions or operating instructions concerned.

3.1.2 Machine user or machine manufacturer obligations

Machine manufacturer obligations

If you have an engine that is not yet installed in a machine, it is imperative that you follow the **Assembly Instructions for HATZ Diesel Engines** before installing the engine. These assembly instructions contain important information on how to safely install the engine and are available at your nearest **HATZ service station**.

It is prohibited to start the engine before it is fully installed.

In addition, please note that it is prohibited to start up the machine before it has been determined that the machine into which this engine is installed fulfills all safety-related requirements and legal regulations.

User obligations

The operator is obliged to only operate the machine when it is in perfect condition. The operator must check the condition of the machine before use and ensure that any defects are eliminated before it is taken into service. Operating the machine while identified defects exist is not permitted. The operator must also ensure that all persons who work on the machine are familiar with the contents of this manual.

Obligations of the operating and maintenance personnel

Personnel assigned with operating and maintaining the machine must have read and understood this manual or must possess the qualifications necessary for working with this equipment, acquired in training/instructional courses. No one may work with the machine without the necessary qualifications, even if for just a brief period.

The operating and maintenance personnel must not be under the influence of drugs, medication or alcohol.

All work performed on the machine must be in compliance with the information provided in this manual.

Storing this manual

This manual is an integral component of the machine (also when being sold). It must be stored in the direct vicinity of the machine and be accessible to personnel at all times.

3.1.3 Representation of safety notes

Overview

This machine has been designed and built according to state-of-the-art technology and the recognized safety standards. Despite these precautions, risks exist when operating the machine and during maintenance work.

These risks are identified in this manual by means of safety notes.

The safety notes precede the relevant description or operating step.

Structure of the safety notes

The safety notes consist of:

- Danger symbol
- Signal word
- Description of the danger
- Possible consequences
- Preventative measures



General danger symbol



The general danger symbol is used to identify the danger of personal injury.

Signal words





Signal words identify the magnitude of the risk and the seriousness of possible injury:



Danger symbol/ signal word	Meaning
 DANGER	This signal word is used to indicate imminently dangerous situations which, if not avoided, will lead to serious injury or death.
 WARNING	This signal word is used to indicate potentially dangerous situations which, if not avoided, may lead to serious injury or death.
 CAUTION	This signal word is used to indicate potentially dangerous situations which, if not avoided, may lead to minor or moderate injury.
CAUTION	This signal word, without a danger symbol, is used to indicate the risk of property damage.
NOTICE	This signal word indicates additional useful information, such as operating tips and cross references.

3.1.4 Meaning of safety symbols

Explanation of symbols

The following table describes the meanings of the safety symbols used in this manual.

Symbol	Meaning
	Smoking, fire, and open flames are prohibited!
	Warning of personal injury!
	Warning of hot surfaces!
	Warning of hot surfaces! (Alternative)



Symbol	Meaning
	Warning of flammable substances!
	Warning of explosive substances!
	Warning of toxic engine exhaust!
	Warning of corrosive substances!
	Warning of heavy loads!
	Warning of environmental damage!
	Comply with this manual or additional documentation from other manufacturers or the operator.
	Additional information that is useful to the reader.

3.2 Safety notes

3.2.1 Operational safety

Introduction

This chapter contains all of the important safety instructions for personal protection and for safe and reliable operation. Additional, task-related safety instructions can be found at the beginning of each chapter.

 DANGER	
	<p>Danger to life, danger of injury or danger of property damage due to failure to comply with this manual and the safety instructions contained therein.</p> <ul style="list-style-type: none">▪ As the operator of the machine, you must ensure that all people working on the machine are familiar with the content of this manual.▪ Before working on the machine, read this manual carefully, paying special attention to the safety notes.▪ Fulfill all required safety conditions before working on the machine.▪ Follow all general safety instructions as well as the specific task-related safety instructions contained in the individual chapters.

Using the machine







- Only operate the machine for the purposes described in chapter 3.1.1 *Intended use*, page 7.

Compliance with other regulations

- The applicable regulations of the relevant professional associations must be observed.
- Comply with the regulations concerning the minimum safety and health requirements for the use of work equipment by workers at work.
- In addition, local safety, accident prevention and environmental regulations also apply when operating the machine.

Personal protective equipment

During operation and maintenance of the machine, personal protective equipment must be available and must be used if necessary. The use of personal protective equipment is specified in the description of the operating steps.

Personal protective equipment	Pictogram	Function
Safety shoes		Safety shoes offer protection against: <ul style="list-style-type: none"> ▪ Slipping ▪ Falling objects
Hearing protection		Hearing protection offers protection against ear injuries due to excessive and constant noise.
Safety gloves		Safety gloves protect the hands against injury, e.g., from battery acid.
Safety goggles (with side protection)		Safety goggles protect the eyes from flying objects (e.g., dust particles, spraying liquids, spraying acid).
Fine dust mask		A fine dust mask protects the wearer against particulate pollutants.
Working clothes		Wear close-fitting working clothes. It must not restrict the wearer's freedom of movement, however.

Warning labels and information signs on the machine

The warning labels and information signs on the machine must be followed (see chapter "Labels" 3.3 *Labels*, page 20).

The warning labels and information signs must be kept legible and must be replaced if necessary. For this purpose, contact your nearest **HATZ service station**.

Maintenance work









Maintenance work that goes beyond the scope described in this manual must only be performed by qualified technicians (see chapter 2 *General information*, page 6).

Independent maintenance work and constructional changes to the machine, especially to the safety equipment, are not permitted.

Safety equipment

Safety equipment must not be modified and must not be rendered ineffective during normal operation.

General safety instructions

 DANGER	
	<p>Danger to life and danger of injury due to failure to follow the warnings on the machine and in this manual.</p> <ul style="list-style-type: none"> ▪ Heed the warnings on the machine and in this manual.
 WARNING	
	<p>Danger of injury and danger of incorrect operation due to inadequate personnel qualifications.</p> <ul style="list-style-type: none"> ▪ The personnel must have read and understood this manual or must possess the qualifications necessary for working with this equipment, acquired in training/instructional courses. ▪ Only qualified personnel is permitted to operate and maintain this machine. ▪ Failure to comply will cause the warranty to become void.
 WARNING	
	<p>Danger of injury from failure to follow the Operating Instructions and from performing unauthorized tasks on the machine.</p> <ul style="list-style-type: none"> ▪ Follow all instructions. ▪ Do not perform activities for which no qualification is available. Contact properly trained personnel if necessary.
 CAUTION	
	<p>Danger of injury from overloading the body.</p> <p>Lifting the machine to transport it or to move it to another location can lead to injuries (of the back, for example).</p> <ul style="list-style-type: none"> ▪ Only lift the machine with a hoist (see chapter 6.1 <i>Transport</i>, page 33).

3.2.2 Machine-specific safety instructions for operation

Introduction

The machine can pose residual risks during operation. To eliminate these risks, all persons working on the machine must follow the general and machine-specific safety instructions.

If you have an engine that is not yet installed in a machine, it is imperative that you follow the **Assembly Instructions for HATZ Diesel Engines** before installing the engine.

These Assembly Instructions contain important information on safe installation.

If the engine is installed in a machine or assembled with other machines to form a machine, it is prohibited to start the engine before it has been determined that the newly created machine fulfills all safety-related requirements and applicable legal regulations.



Safe operation







- Before switching on the machine, ensure that no one can be injured when the machine is started up.
- During machine operation, ensure that unauthorized persons do not have access to the area in which the machine has an impact.
- Parts of the exhaust gas system and the surface of the engine become hot during operation. Risk of injury from touching hot parts! Let the engine cool before maintenance.
- Do not refuel during operation.

Faults

- Immediately eliminate faults that compromise safety.
- Switch off the machine and do not take into service again until all faults have been eliminated.

Safety instructions for operation

 DANGER	
	<p>Danger to life from inhaling exhaust gases.</p> <p>Toxic engine exhaust gases can lead to loss of consciousness, and even death, in closed-off and poorly ventilated rooms.</p> <ul style="list-style-type: none"> ▪ Never operate the machine in closed-off or poorly ventilated rooms. ▪ Do not breathe in the exhaust gases.

 DANGER	
	<p>Danger of fire from hot exhaust gas system.</p> <p>If inflammable materials come into contact with the exhaust gas flow or the hot exhaust gas system, these materials can ignite.</p> <ul style="list-style-type: none"> ▪ Keep inflammable materials away from the exhaust gas system. ▪ Do not operate the engine (exhaust flow or hot exhaust gas system) in the direct vicinity of combustible materials.
 DANGER	
 	<p>Fire hazard from fuel.</p> <p>Leaked or spilled fuel can ignite on hot engine parts and cause serious burn injuries.</p> <ul style="list-style-type: none"> ▪ Only refuel when the engine is switched off and has cooled down. ▪ Never refuel in the vicinity of open flames or sparks that can cause ignition. ▪ Do not smoke. ▪ Do not spill fuel.
 CAUTION	
	<p>Danger of injury from faulty starter rope.</p> <p>A chafed starter rope can rip and cause injuries.</p> <ul style="list-style-type: none"> ▪ Before using the starter rope, check for abrasion; replace the rope if necessary.

3.2.3 Machine-specific safety instructions for maintenance work

Introduction

The machine can pose residual risks during maintenance. To eliminate these risks, all persons working on the machine must follow the general and machine-specific safety instructions.

Maintenance intervals

- Strictly adhere to the maintenance intervals.
Regular maintenance according to the instructions in this manual is essential for ensuring reliable operation and the correct engine exhaust quality.
- Check the safety equipment regularly to ensure it is in good condition and functioning properly.

- Check connections, cables and fasteners regularly to ensure they are in good condition.

Maintenance work

Maintenance work that goes beyond the scope described in this manual must only be performed by qualified technicians. We recommend that you work with one of the over 500 **HATZ service stations**.





Replacing parts





- When replacing defective components, we recommend that you use **Hatz original spare parts** (see chapter 2 *General information, page 6*).
- When disposing of parts that can no longer be used, do so in accordance with local environmental regulations or send them to a recycling center.

Measures following maintenance and troubleshooting

- Securely reconnect loose electrical connections; check that the electrical components and equipment are functioning properly.
- Check the entire machine for foreign bodies; remove any foreign bodies.



Safety instructions for maintenance work

 DANGER	
	<p>Danger of explosion from flammable cleaning agents.</p> <p>Cleaning with benzene is an explosion hazard. It is highly flammable, can become electrostatically charged, and can generate an explosive gas/air mixture.</p> <ul style="list-style-type: none"> ▪ Use halogen-free, cold cleaners with a high flash point for cleaning. ▪ Comply with manufacturer's instructions.
 WARNING	
 	<p>Danger of injury from compressed air and dust particles.</p> <p>Eye injuries can occur when cleaning with compressed air.</p> <ul style="list-style-type: none"> ▪ Wear safety goggles.

 CAUTION	
	<p>Danger of injury from ignoring the maintenance instructions.</p> <ul style="list-style-type: none"> ▪ Only perform maintenance work when the engine is switched off. ▪ Protect start-up devices (crank handle, recoil start or starting key) from unauthorized access. ▪ For engines with a starter: Disconnect the negative battery terminal. ▪ When the maintenance work has been completed, ensure that all tools are removed from the machine.
 CAUTION	
	<p>Danger of burns.</p> <p>There is a danger of burns when working on a hot engine.</p> <ul style="list-style-type: none"> ▪ Let the engine cool before maintenance.

3.2.4 Electrical equipment

Safety notes

 DANGER	
	<p>Danger to life, danger of injury or danger of property damage due to incorrect use of batteries.</p> <ul style="list-style-type: none"> ▪ Do not place tools or other metal objects on the battery. ▪ Before performing work on the electrical equipment, always disconnect the negative battery terminal. ▪ Never swap the plus (+) and negative (–) battery terminals. ▪ When installing the battery, first connect the plus cable and then the negative cable. ▪ When removing the battery, first disconnect the negative cable and then the plus cable. ▪ It is imperative to prevent short circuits and mass contact of current carrying cables. ▪ If faults occur, check the cable connections for good contact.

**DANGER****Danger of explosion from flammable substances.**

There is a danger of explosion from flammable gases.

- Keep batteries away from open flames and incendiary sparks.
- Do not smoke when working with batteries.

**CAUTION****Danger of chemical burns**

Chemical burns can occur when using batteries for the electrical operation.

- Protect your eyes, skin, and clothing from corrosive battery acid.
- Immediately rinse areas affected by splashed acid with clear water and consult a physician if necessary.

- Promptly replace defective indicator lamps.
- Do not disconnect the battery while the machine is running. Resulting voltage peaks could destroy the electronic components.
- When cleaning, do not spray the electrical equipment components with a water jet or high pressure cleaner.
- When performing welding work on the machine, disconnect the battery and place the ground clamp of the welding equipment as close as possible to the welding area. Disconnect the plug connectors to the engine control unit and to the voltage regulator of the alternator.

NOTICE

- We cannot be held liable for electrical equipment that is not designed according to HATZ wiring diagrams.

3.3 Labels

Warning labels and information signs on the engine

Label	Meaning
	<p>Maintenance instructions (see chapter 8.2 <i>Maintenance work</i>, page 53)</p>
	<p>Emergency hand start with recoil start (see chapter 9.3 <i>Emergency hand start</i>, page 84)</p>
	<p>CAUTION! Danger of injury from faulty starter rope. A chafed starter rope can rip and cause injuries.</p> <ul style="list-style-type: none"> Before using the starter rope, check for abrasion; replace the rope if necessary.
	<p>Refuel with diesel fuel only. For the specification, see chapter 4.4 <i>Fuel</i>, page 26.</p>

4 Technical data

4.1 Engine information and filling quantities

Type		1B30E	1B50E
Type		Air cooled, four stroke diesel engine	
Combustion system		Direct injection	
Number of cylinders		1	1
Bore/Stroke	mm	80 / 69	93 / 76
Displacement	cm ³	347	517
Tank capacity	Ltr.	5	5
Engine oil capacity			
Without oil sump	Approx. ltr.	1,1 ¹⁾	1.5 ¹⁾
With oil sump	Approx. ltr.	2,5 ¹⁾	3.2 ¹⁾
Difference between "max" and "min" marking			
Without oil sump	Approx. ltr.	0,5 ¹⁾	0.8 ¹⁾
With oil sump	Approx. ltr.	1,5 ¹⁾	2.2 ¹⁾
Engine oil consumption (after running-in period)	Max.	1 % of fuel consumption, pertaining to full load	
Engine oil pressure at oil temperature of 100 °C	Approx.	2.5 bar at 3000 rpm	
Sense of rotation on power take-off side		Left	
Tappet clearance at 10–30 °C inlet/outlet	mm	0.10	0.10
Weight (incl. fuel tank, air filter, silencer and electric start)	Approx. kg	41	58
Battery capacity	Max.	12 V – 55 Ah / 420 A (EN) / 450 A (SAE)	

¹⁾ These values are approximations only. The max. mark on the dipstick is decisive in any case (see chapter 7.5 *Check the oil level, page 45*).

Maximum permissible inclination during continuous operation *

1B30E and 1B50E without additional oil pan

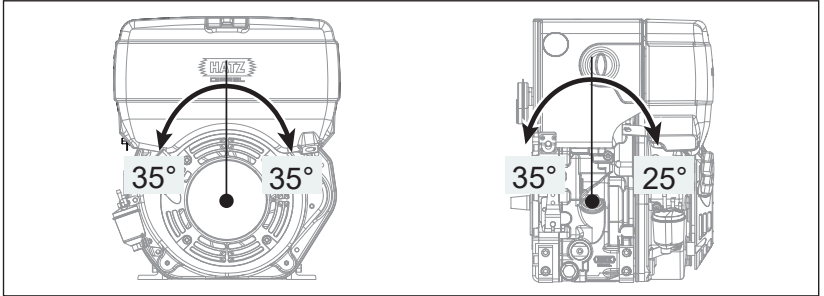

**1B30E with additional oil pan and a maximum speed of up to 2500 rpm
1B50E with additional oil pan at all speeds**

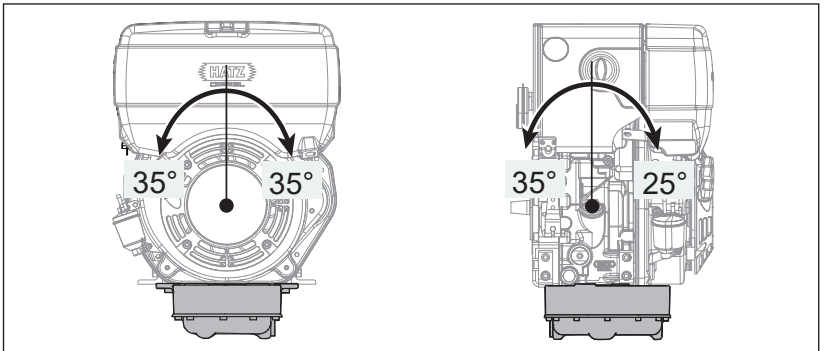

1B30E with additional oil pan and a maximum speed above 2500 rpm

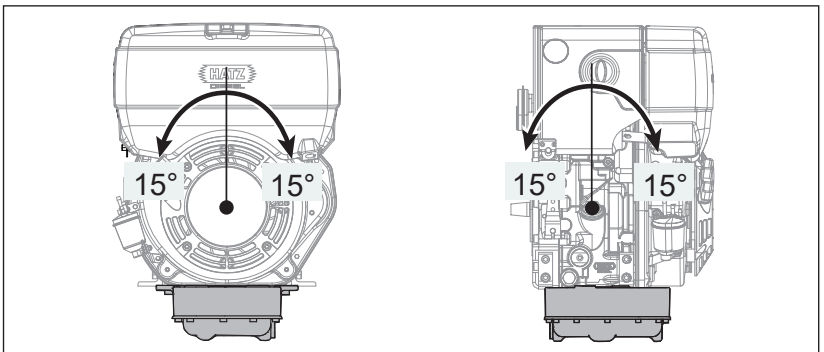

* Exceeding these limit values causes engine damage.

Engine specifications

Model	Description
T	Normal counter balance (1B50ET only)
U	Additional counter balance (1B50EU only)

Screw tightening torque

Designation	Nm
Oil drain screw	50

4.2 Engine type plate

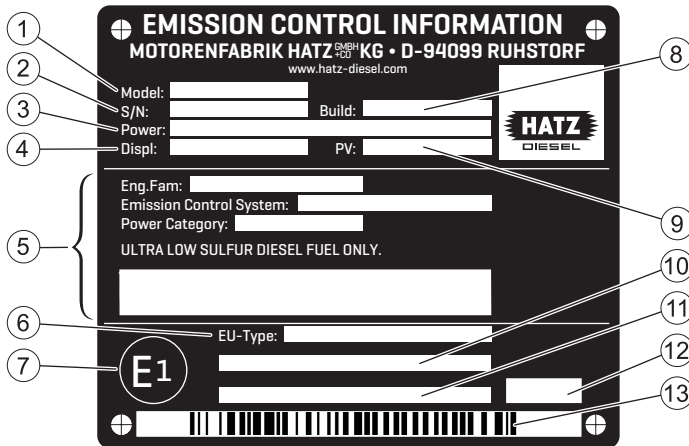

The layout of the EPA/CARB type plate depends on the engine application and is affixed to the sound protection hood. It contains the following information:

1	Model designation of the engine
2	Engine serial number
3	Engine power (kW) at rated speed (rpm)
4	Displacement (liters)
5	Information for US emission certification (EPA/CARB)
6	EU type approval number
7	EU country of origin (Germany)
8	Model year (month/year)
9	Test specification for special settings
10	Engine family designation or exemption code (EM) or transition code (TM) according to regulation (EU) 2016/1628

11	Additional specifications according to Regulation 2017/656 (exceptions) or "Separate shipment information"
12	Code for type plate variant
13	Barcode (engine serial number)

The type plate also defines the applicable emissions-related performance class of the engine.

The figure shows an EPA/CARB type plate.

A text that refers to the exhaust legislation and corresponds to the engine type is printed on the type plate (EPA or EPA and CARB).

Every engine is equipped with an additional unattached type plate. When the engine is built into a machine and the original type plate is not readily visible, the second unattached type plate must be affixed to the application in a position that is clearly visible for an average person.

The following data must always be specified in case of queries and for spare parts orders:

1	Model designation
2	Engine serial number
3	Rated speed (rpm)

Always install the engine appropriate for the intended application to fulfill the EPA and CARB exhaust requirements.

4.2.1 Engine serial number

Breakdown of the engine serial number

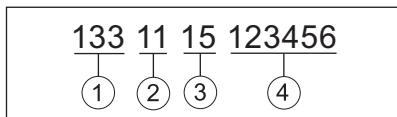

1	Engine type number
2	Engine serial number
3	Model year
4	Fabrication number (consecutive)

4.3 Engine oil

Oil quality

All oil brands that meet at least one of the following specifications are suitable:

- **ACEA E6 or E8** (recommended)
- **ACEA E9 or E11**
- **ACEA C3 / C4** (HTHS ≥ 3.5 mPas)
- **API CK-4 or CJ-4**

CAUTION

Damage to the diesel oxidation catalyst (DOC) from using unsuitable engine oil.

Unsuitable engine oil diminishes the functionality and service life of the catalytic converter.

Only use engine oils with very low quantities of sulfate ash, phosphor and sulfur – so-called "low SAPS" oils which fulfill at least one of the specifications mentioned above.

Oil viscosity

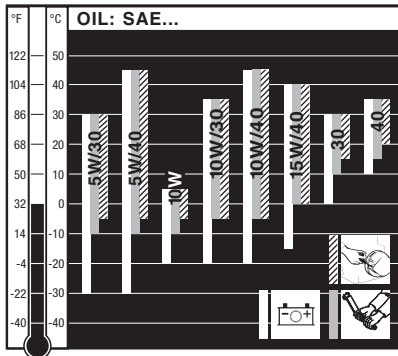

Choose the recommended viscosity based on the type of start (recoil, crank handle or electric) and on the engine temperature at which the engine will be operated.

CAUTION

Engine damage from unsuitable engine oil.

Unsuitable engine oil considerably reduces engine service life. Only use engine oil that fulfills the specifications stipulated above.

4.4 Fuel

Fuel type

All types of diesel fuel that meet the minimum requirements of the following specifications are suitable:

- **Europe: EN 590**
- **UK: BS 2869 A1 / A2**
- **USA: ASTM D 975-09a 1-D S15 or 2-D S15**

CAUTION

Danger of engine damage from low quality fuel.

The use of fuel that does not meet the specifications can lead to engine damage.

- The use of fuels that do not meet specifications require approval by Motorenfabrik HATZ (main plant).

CAUTION

Danger of malfunctions due to old fuel.

When diesel fuel is stored in a fuel tank or canister for lengthy periods, deposits may form on account of fuel aging. These deposits result in malfunctions due to clogged fuel filters and damage to the injection system.

- Perform the prescribed storage steps in machines that will be out of use for more than three months (see chapter 10.1 *Storing the machine, page 89*).
- Only refuel with fresh diesel fuel such as can be obtained from filling stations.

Winter fuel

Diesel fuel loses its fluidity at low temperatures, which can lead to operating problems. Use cold-resistant winter diesel fuel for outside temperatures below 0 °C.

5 Engine overview

5.1 Designation of components

Intake side

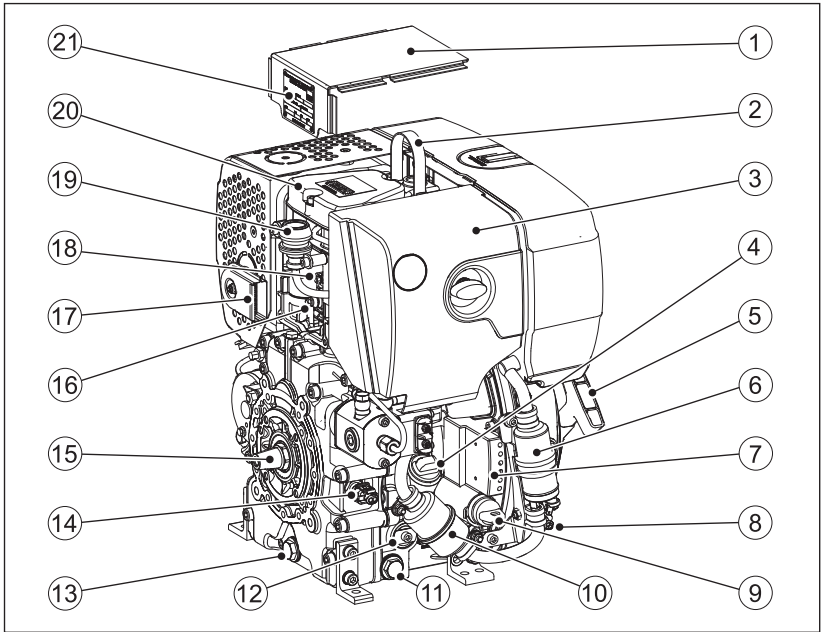

1	Sound protection hood
2	Lifting eye
3	Dry air filter
4	Oil filling opening and dipstick
5	Handle for emergency hand start system (option)
6	Electric fuel pump
7	Indicator lamps
8	Crankshaft speed sensor
9	Ignition lock
10	Main fuel filter
11	Side oil drain screw
12	Screw plug for oil filter
13	Oil drain screw, front

14	Oil temperature sensor
15	Crankshaft – power take-off (pto)
16	Oil pressure switch
17	Exhaust manifold with exhaust screen (exhaust outlet: lateral)
18	Temperature switch
19	Air filter maintenance indicator (option)
20	Cylinder head cover
21	Type plate

Exhaust side

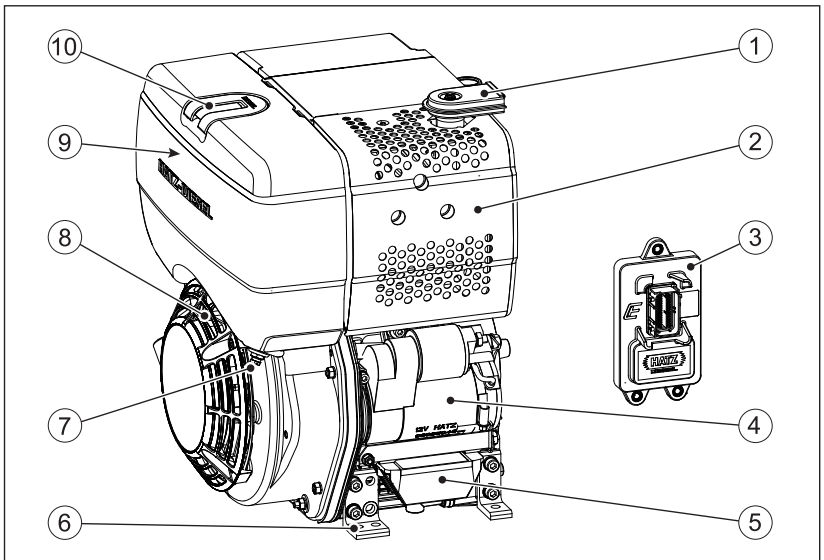

1	Exhaust manifold with exhaust screen (exhaust outlet: top)
2	Silencer with contact protection
3	Engine control unit
4	Starter
5	Voltage controller
6	Engine bracket
7	Water separator
8	Intake opening for cooling and combustion air
9	Fuel prefilter (in tank)

10

Fuel cap

5.2 HATZ instrument box

Overview

Standard (instrument box attached on the engine)

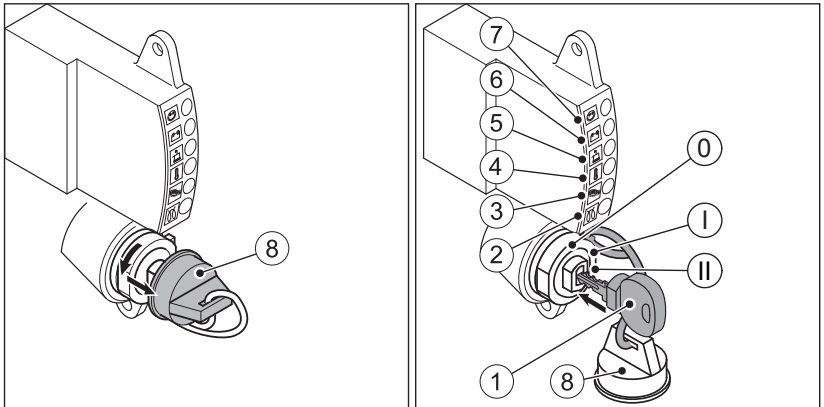



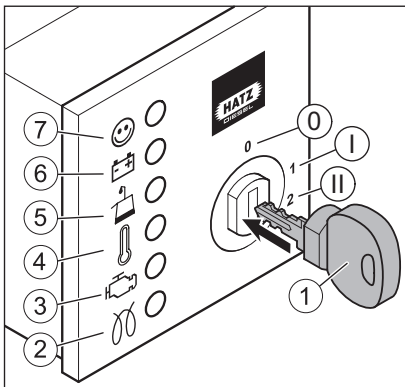

Option (external instrument box)





1	Starting key
2	Pre-glow indicator (option)
3	Engine fault
4	Engine temperature indicator
5	Oil pressure indicator
6	Charge control
7	Operating indicator
8	Protective cap (only for standard instrument box)

Ignition lock	
0	Off
I	Operation
II	Start

Explanation of symbols







Symbol	Meaning
	<p>Operating indicator Lights up during operation when there is no engine fault.</p>
	<p>Charge control Fault in the alternator or alternator charging circuit. The battery is no longer charged. Eliminate the fault immediately.</p>
	<p>Oil pressure indicator Engine oil pressure too low. Danger of engine damage. Stop the engine immediately and check the oil level (see chapter 7.5 <i>Check the oil level, page 45</i>). Contact the HATZ service if the oil level is correct.</p>
	<p>Engine temperature indicator Engine temperature is impermissibly high. Danger of engine damage. Switch off the engine immediately! For details of troubleshooting, see chapter 9.1 <i>Troubleshooting, page 78</i>.</p>
	<p>Engine fault (symbol with external instrument box) This indicator lights up or flashes if there are engine faults. For details on troubleshooting measures, see 9.2 <i>Flash code table for engine faults, page 81</i>.</p> <p>Depending on the engine specification, the engine controller reacts as follows in case of a malfunction:</p> <ul style="list-style-type: none"> ▪ Emergency operation The engine switches to emergency operation. In this situation, the engine power is reduced or the maximum speed is limited. The engine malfunction indicator lights up. ▪ Engine stop The engine switches off automatically. The engine malfunction indicator flashes. ▪ Warning lamp Only the engine malfunction indicator calls attention to a malfunction.

Symbol	Meaning
	<p>Engine fault (symbol with instrument box built onto engine) This indicator lights up or flashes if there are engine faults. For details on troubleshooting measures, see <i>9.2 Flash code table for engine faults, page 81</i>.</p> <p>Depending on the engine specification, the engine controller reacts as follows in case of a malfunction:</p> <ul style="list-style-type: none">▪ Emergency operation The engine switches to emergency operation. In this situation, the engine power is reduced or the maximum speed is limited. The engine malfunction indicator lights up.▪ Engine stop The engine switches off automatically. The engine malfunction indicator flashes.▪ Warning lamp Only the engine malfunction indicator calls attention to a malfunction.
	<p>Pre-glow indicator Lights at temperatures below 0 °C. Start the engine after the indicator has gone out.</p>

6 Transport, installation and commissioning

6.1 Transport

Safety notes

 WARNING	
	<p>Danger of injury from improper lifting and transport.</p> <p>Danger of crushing from the engine falling or tipping.</p> <ul style="list-style-type: none"> ▪ Only use the lifting eye already mounted on the machine for lifting. ▪ Before lifting the engine, check the lifting eye for damage. Lifting with a damaged lifting eye is not permitted. Replace a damaged lifting eye before using it for lifting. ▪ Only use a suitable hoist with a sufficient carrying capacity. ▪ Do not remain under suspended loads.
 CAUTION	
	<p>Only use the lifting eye for transporting the engine.</p> <p>Do not use for lifting the entire machine.</p>
 CAUTION	
	<p>Danger of injury from overloading the body.</p> <p>Lifting the machine to transport it or to move it to another location can lead to injuries (of the back, for example).</p> <ul style="list-style-type: none"> ▪ Only lift the machine with a hoist.
NOTICE	
	<p>Danger of environmental damage from leaking fluid.</p> <p>If the machine is tilted, engine oil and fuel can run out.</p> <ul style="list-style-type: none"> ▪ Only transport the machine in an upright position.

Transport conditions

- When transporting the machine, follow the safety instructions.
- When transporting, follow the applicable safety and accident prevention regulations.
- After delivery, check the machine for completeness and transport damage.
- Only transport the machine when it is switched off and has cooled down.

- If you have questions on transporting the machine, please contact your nearest **HATZ service station**. For contact data, see chapter Impressum or www.hatz-diesel.com.

Access to the lifting eye

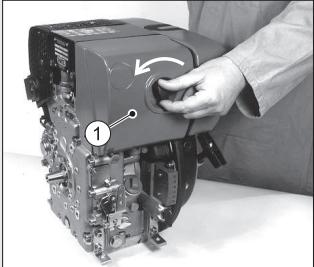
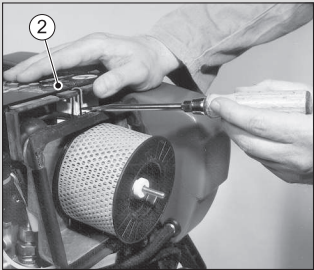
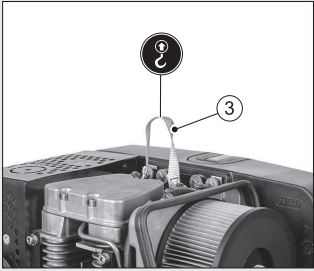
Step	Activity	Figure
1	Unscrew the air filter cover (1).	
2	Remove the sound protection hood (2).	
3	Attach the hoist securely to the lifting eye (3).	
4	After completion of transportation, refit the sound protection hood and cover for the air filter.	

6.2 Installation notes

HATZ diesel engines are efficient, robust, and have a long service life. Therefore, they are usually installed in machines that are used for commercial purposes.

The machine manufacturer must follow the applicable regulations regarding machine safety – the engine is a part of a machine.

Depending on the use and installation of the engine, it may be necessary for the machine manufacturer and machine user to install safety equipment to prevent inappropriate use. Note the following:

- Parts of the exhaust gas system and the engine surface become hot during operation and may not be touched until they cool down after the engine is switched off.
- Incorrect cable connections and incorrect operation of the electrical equipment can lead to sparking and must be avoided.
- After the engine is installed in the machine, rotating parts must be protected against contact.
HATZ safety equipment is available for the belt drive of the cooling fan and alternator.
- Comply with all notices and warning labels on the engine and keep them in a legible condition. If an adhesive label should become detached or difficult to read, it must be replaced promptly. For this purpose, contact your nearest **HATZ service station**.
- Any improper modification of the engine will result in a loss of liability coverage for resulting damage.



Only regular maintenance, as specified in this manual, will maintain the operating readiness of the engine.

The **assembly instructions** contain important information on how to safely assemble the engine. They are available from any **Hatz service station**.

If you have any questions, please contact your nearest **HATZ Service** before commissioning the engine.

6.3 Preparations for commissioning



- Check the delivered parts for completeness, damage, and other noticeable issues.
- Ensure that the setup location is adequately ventilated.

 DANGER	
	<p>Danger to life from inhaling exhaust gases.</p> <p>Toxic engine exhaust gases can lead to loss of consciousness, and even death, in closed-off and poorly ventilated rooms.</p> <ul style="list-style-type: none"> ▪ Never operate the machine in closed-off or poorly ventilated rooms. ▪ Do not breathe in the exhaust gases.

6.4 Filling engine oil (first filling)

Engines are normally delivered without an engine oil filling.

Safety notes

 CAUTION	
 	<p>Danger of injury</p> <p>Prolonged contact with engine oil can lead to irritation of the skin.</p> <ul style="list-style-type: none"> ▪ Wear safety gloves. ▪ If there is contact with the skin, thoroughly wash the affected areas of the skin with soap and water.
CAUTION	
	<p>Danger of later engine damage.</p> <ul style="list-style-type: none"> ▪ Operating the engine with an oil level below the min. mark or above the max. mark can lead to engine damage. ▪ When checking the oil level, the engine must be horizontal and have been switched off for a few minutes.

Overview

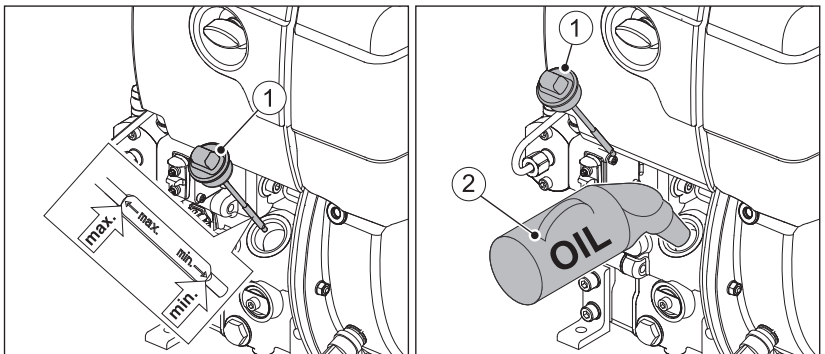

1	Dipstick
2	Oil refilling container

Procedure

Step	Activity
1	Unscrew the dipstick (1) and clean it.

Step	Activity
2	Fill engine oil. For the specification and viscosity, see chapter 4.3 <i>Engine oil</i> , page 25. See chapter 4.1 <i>Engine information and filling quantities</i> , page 21 for the engine oil capacity.
3	Reinsert the dipstick and screw it tight.
4	Unscrew the dipstick and check the oil level.
5	If required, add engine oil to the max. mark.
6	Reinsert the dipstick and screw it tight.

6.5 Venting the fuel system

Requirements

The fuel system must be bled in the following situations:

- At first filling of the fuel tank
- After changing the fuel filter
- Engine shuts down due to empty fuel tank

Overview

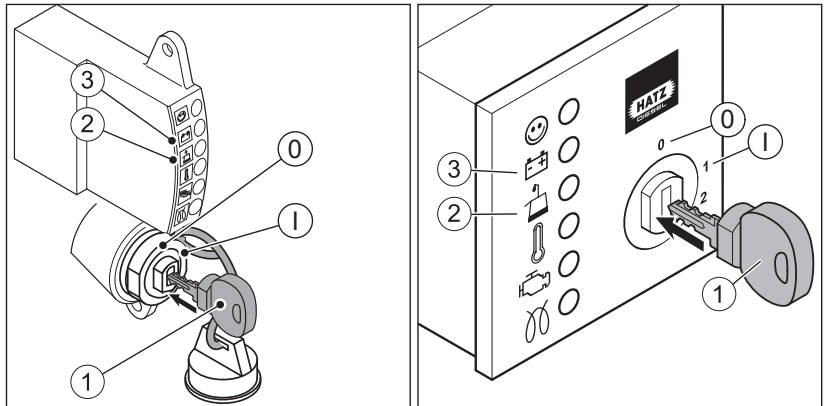

1	Starting key
2	Oil pressure indicator
3	Charge control

Ignition lock

0	Off
I	Operation

Procedure

Step	Activity
1	Insert the starting key all the way and turn to position "I". The oil pressure indicator (2) and charge control (3) light up.
2	Leave the starting key at position "I" until you hear the electrical fuel feed pump switch off (approx. 10 seconds).
3	Turn the starting key back to position "0". <i>Note:</i> Carry out steps 2 and 3 several times to press the air out of the fuel system.
4	After bleeding, multiple start attempts with the starter are necessary to start the engine. Start the engine (see chapter 7.3 <i>Starting the engine</i> , page 40)

7 Operation and use

7.1 Safety notes

NOTICE



Comply with the safety chapter!

Follow the basic safety instructions in chapter 3 *Safety*, page 7.



WARNING



Danger of injury from damage and defects on the machine.

- Do not take the machine into service if damage has been localized and identified.
- Replace defective components.



WARNING



Danger of injury from failure to follow the operating instructions and from performing unauthorized tasks on the machine.

- Define the responsibilities of the personnel taking the machine into service.
- Replace defective machine parts immediately.
- Check the installation conditions when the machine is first taken into service and after the machine has been inactive for a lengthy period.

CAUTION

Danger of engine damage from low load operation.

Operating the engine at no load or at very low load for an extended period can impair the running characteristics of the engine.

- Make sure that the engine load is at least 15 %.
- Before switching off the engine following low load operation, briefly operate it at a considerably higher load.

7.2 Performing tests

Before starting

Before starting the engine, several tests need to be performed to ensure the machine is working properly.



Procedure

Step	Test
1	The machine is standing securely and on a level surface.
2	The installation location is adequately ventilated.
3	There is a sufficient amount of fuel in the fuel tank (see chapter 7.6 <i>Refueling</i> , page 47).
4	There is a sufficient amount of engine oil in the engine housing (see chapter 6.4 <i>Filling engine oil (first filling)</i> , page 36).
5	No persons are located in the danger zone of the engine or machine.
6	All safety equipment is in place.

7.3 Starting the engine

If possible, separate the engine from the machine being driven by uncoupling it. Always switch the machine into idle mode.

Safety notes

 DANGER	
	<p>Danger to life from inhaling exhaust gases.</p> <p>Toxic engine exhaust gases can lead to loss of consciousness, and even death, in closed-off and poorly ventilated rooms.</p> <ul style="list-style-type: none"> ▪ Never operate the machine in closed-off or poorly ventilated rooms. ▪ Do not breathe in the exhaust gases.
CAUTION	
	<p>Danger of engine damage from the use of starting fluid.</p> <ul style="list-style-type: none"> ▪ Engine damage from the use of starting fluid can lead to uncontrolled ignition. ▪ Engine damage from uncontrolled ignition. ▪ Never use starting fluid.

NOTICE

See also starting instructions in the documentation for the complete machine.

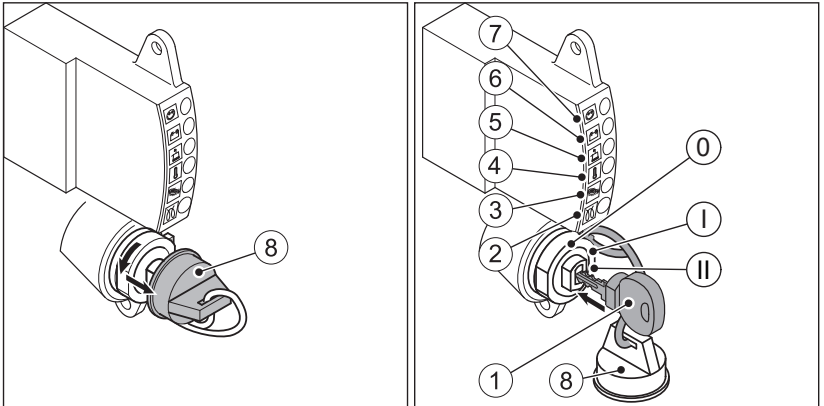
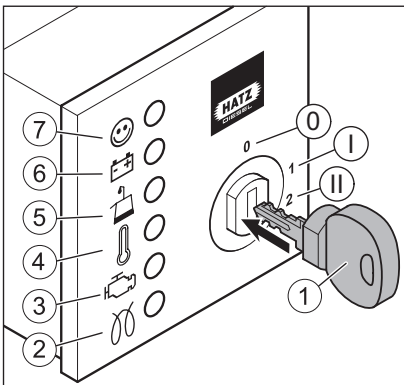
Overview – HATZ instrument boxes**Standard (instrument box attached on the engine)****Option (external instrument box)**

1	Starting key
2	Pre-glow indicator (option)
3	Engine fault
4	Engine temperature indicator
5	Oil pressure indicator

6	Charge control
7	Operating indicator
8	Protective cap (only for standard instrument box)
Ignition lock	
0	Off
I	Operation
II	Start

NOTICE

For further details on the instrument box, see chapter 5.2 *HATZ instrument box*, page 30.

Procedure**NOTICE**

- Start for max. 30 seconds. If the engine is still not running after that, turn the starting key back to position "0" and eliminate the cause (see chapter 9.1 *Troubleshooting*, page 78).
- Turn the starting key to position "0" every time you want to start the engine.
- The anti repeat device in the ignition lock makes it impossible for the starter to engage while the engine is running and become damaged.

Step	Activity
1	Remove the protective cap (8) from the ignition lock (only for standard instrument box).
2	Insert the starting key all the way and turn to position "I". The oil pressure indicator (5) and charge control (6) light up. When the pre-glow indicator (2) lights up, wait until it goes out and then continue with the next step.
3	Turn the starting key to position "II".

Step	Activity
4	<p>As soon as the engine is running, release the starting key.</p> <ul style="list-style-type: none"> ▪ The starting key springs back to position "I" and remains in this position during operation. ▪ The oil pressure indicator (5) and charge control (6) must go out. ▪ The operating indicator (7) lights up and signals that there is no engine fault.

NOTICE



- In case of irregularities, switch off the engine immediately.
- Identify the fault and eliminate it.
- For details of troubleshooting, see chapter 9.1 *Troubleshooting*, page 78.

7.4 Switching off the engine

Safety notes



CAUTION



Danger of injury from unauthorized access.

There is a danger of injury if unauthorized persons handle the machine.

- Protect the starting key against unauthorized access during breaks in operation or after completing work.

CAUTION

Protect the ignition lock against dirt and moisture.

- With the starting key pulled out, seal the ignition lock with the protective cap.

Overview – HATZ instrument boxes

Standard

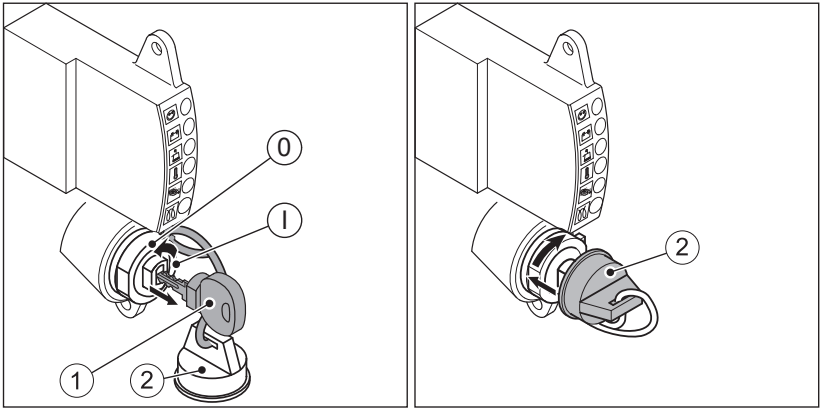

Option

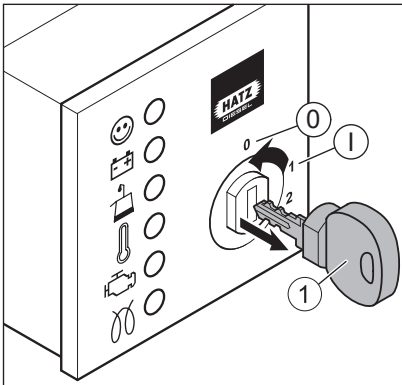

1	Starting key
2	Protective cap (only for standard instrument box)
Ignition lock	
0	Off
1	Operation

Procedure

Step	Activity
1	<p>Turn the starting key to position "0".</p> <p>The engine switches off.</p> <p>All indicator lamps go out.</p> <p><i>Note:</i></p> <p>The engine continues running for several seconds after it is switched off. Before performing any further activities, wait until all moving components have come to a complete standstill.</p>
2	Remove the starting key.
3	Close the ignition lock with the protective cap (only for standard instrument box).

NOTICE**Danger of exhaustive battery discharge.**

- When the machine is switched off, always turn the starting key to position "0" or else the battery may become fully discharged.

7.5 Check the oil level**Safety notes****CAUTION****Danger of burns.**

- There is a danger of burns when working on a hot engine.
- Wear safety gloves.

**CAUTION****Danger of injury**

Prolonged contact with engine oil can lead to irritation of the skin.

- Wear safety gloves.
- If there is contact with the skin, thoroughly wash the affected areas of the skin with soap and water.



CAUTION**Danger of later engine damage.**

- Operating the engine with an oil level below the **min.** mark or above the **max.** mark can lead to engine damage.
- When checking the oil level, the engine must be horizontal and have been switched off for a few minutes.

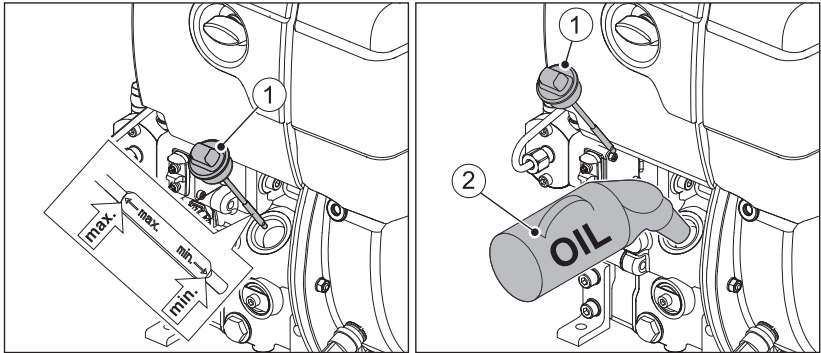
Overview









1	Dipstick
2	Oil refilling container

Procedure

Step	Activity
1	Switch off the engine and wait several minutes for the engine oil to collect in the crankcase. Engine must be level.
2	Remove contamination on the engine in the area of the dipstick.
3	Unscrew the dipstick and clean it.
4	Reinsert the dipstick and screw it tight.
5	Unscrew the dipstick and check the oil level.
6	If the oil level is close to the min. mark, add engine oil to the max. mark.
7	Reinsert the dipstick and screw it tight.

7.6 Refueling

Safety notes

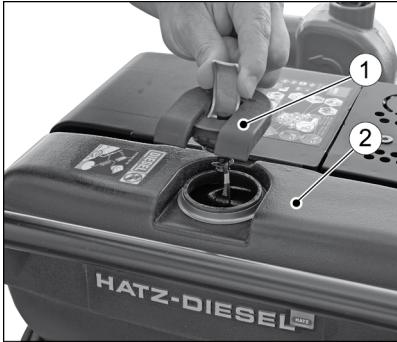

 DANGER	
 	<p>Fire hazard from fuel.</p> <p>Leaked or spilled fuel can ignite on hot engine parts and cause serious burn injuries.</p> <ul style="list-style-type: none"> ▪ Only refuel when the engine is switched off and has cooled down. ▪ Never refuel in the vicinity of open flames or sparks that can cause ignition. ▪ Do not smoke. ▪ Do not spill fuel.
 CAUTION	
	<p>Danger of environmental damage from spilled fuel.</p> <p>Do not overfill the fuel tank and do not spill fuel.</p> <ul style="list-style-type: none"> ▪ Collect any leaking fuel and dispose of it according to local environmental regulations.
 CAUTION	
 	<p>Danger of injury.</p> <p>Repeated contact with diesel fuel can cause chapped and cracked skin.</p> <ul style="list-style-type: none"> ▪ Wear safety gloves. ▪ If there is contact with the skin, thoroughly wash the affected areas of the skin with soap and water.
CAUTION	
	<p>Engine damage from using low quality fuel.</p> <p>The use of fuel that does not meet the specifications can lead to engine damage.</p> <ul style="list-style-type: none"> ▪ Only use the fuel specified in chapter 4.4 <i>Fuel</i>, page 26. ▪ The use of fuels that do not meet specifications require approval by Motorenfabrik HATZ (main plant).

Overview



1	Fuel cap
2	Fuel tank

Procedure

Step	Activity	Figure
1	Open the fuel cap.	
2	Fill the fuel tank with diesel fuel.	

Step	Activity	Figure
3	Close the fuel cap.	

NOTICE



Never run the tank empty if possible, as otherwise air can enter the fuel system. This can lead to damage to the injection system.

If the tank is still run empty, proceed as follows:

- Fill the fuel tank with diesel fuel.
- Bleed the fuel system (see chapter 6.5 *Venting the fuel system*, page 37).

7.7 Checking the water separator

Safety notes



CAUTION



Danger of environmental damage from spilled fuel.

When water is drained from the water separator, a small amount of fuel is drained as well.

- Collect any escaped water/fuel mixture and dispose of it according to local environmental regulations.

NOTICE



The interval for checking the water separator depends entirely on the proportion of water in the fuel and on the care exercised during refueling; the water separator should be checked at least once a week.

Overview

Water in the fuel tank collects at the lowest point of the fuel tank in the water separator.

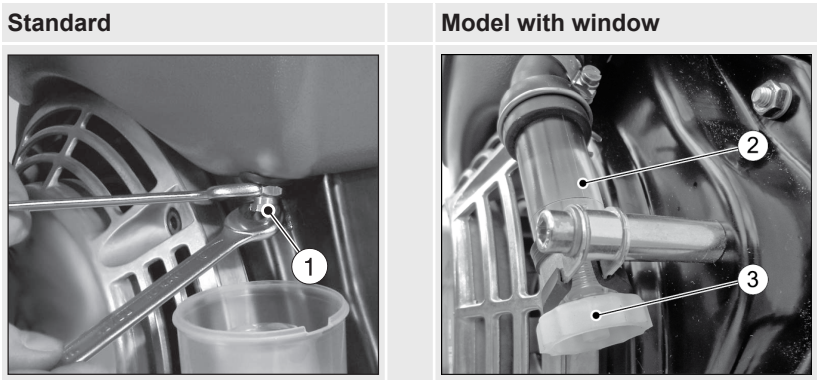

1	Drain screw, hex (standard)
2	Window (additional equipment)
3	Drain screw (manually operated)

Procedure

Step	Activity
1	Model with window: Check the window (2) for water content. Collected water can be clearly identified by the noticeable separating line between the water and the diesel fuel above it.
2	Place a suitable container under the drain screw (1) or (3). <i>NOTE:</i> In inaccessible locations, an extension hose can be mounted on the drain screw (3).
3	Open the drain screw (1) or (3) and drain the water into the container.
4	When fuel emerges, close the drain screw.
5	Dispose of the water/fuel mixture in accordance with the local environmental regulations.

7.8 Check the air filter warning indicator (option)

Overview

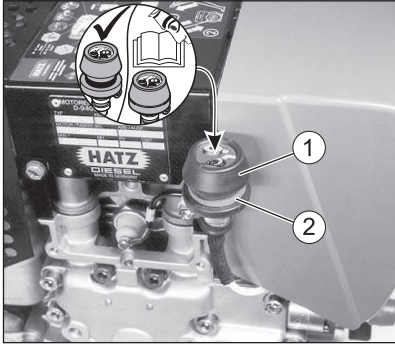

1	Rubber bellow
2	Green field



Procedure

Step	Activity
1	Bring the engine briefly to maximum speed.
2	When the rubber bellow (1) contracts and covers over the green field (2), immediately check the air filter system (see chapter 8.2.11 <i>Maintaining the dry air filter</i> , page 74).
3	Check the rubber bellow (1) several times daily under dusty conditions.

8 Maintenance

8.1 General maintenance instructions

Safety notes

 WARNING	
	<p>Danger of injury from failure to follow the Operating Instructions and from performing unauthorized tasks on the machine.</p> <ul style="list-style-type: none"> ▪ Follow all instructions. ▪ Do not perform activities for which no qualification is available. Contact properly trained personnel if necessary.

NOTICE	
	<p>Comply with the safety chapter!</p> <p>Follow the basic safety instructions in chapter 3 <i>Safety</i>, page 7.</p>

- Maintenance tasks may only be performed by trained personnel.
- Accident prevention measures must be in accordance with the local accident prevention regulations.
- Perform setting and maintenance work at the specified intervals.
- Replace defective machine parts as soon as possible.
- Always wear personal protection equipment.
- Only use fully functional tools.
- Installation of unsuitable spare parts can lead to problems. We cannot accept liability for direct damage or secondary damage that results from this. We therefore recommend the use of **Hatz original spare parts**.
- Closely adhere to the maintenance conditions prescribed in this manual.
- Only make changes to the machine in agreement with the manufacturer.
- Only perform maintenance work when the engine is switched off.
- Protect the starting key from unauthorized access.
- Disconnect the negative battery terminal before carrying out maintenance work.
- Adhere to legal regulations when handling and disposing of used oil, filters, and cleaning agents.
- After completing maintenance work, check that all tools, screws, aids, and other objects are removed from the machine, and that all safety equipment has been replaced.

- Before starting, ensure that no persons are located in the danger zone of the engine or machine.



Performance of maintenance work

The entire machine is designed to be maintenance friendly. Parts that require maintenance are easily accessible.

- Perform maintenance work faithfully at the specified intervals to prevent premature wear of the machine.
- Follow the notice and warning labels on the machine.
- Always retighten screw connections loosened during maintenance work.
- After the necessary maintenance and repair work is completed, perform a function test (test run).
- For maintenance work that is not listed and described in the maintenance documentation, please contact your nearest **HATZ service station**.

8.2 Maintenance work

Safety note

 CAUTION	
	<p>Danger of injury from ignoring the maintenance instructions.</p> <ul style="list-style-type: none"> ▪ Only perform maintenance work when the engine is switched off. ▪ Protect the starting key from unauthorized access. ▪ Disconnect the negative battery terminal. ▪ When the maintenance work has been completed, ensure that all tools are removed from the machine.

8.2.1 Maintenance notice label

NOTICE	
	<p>The illustrated maintenance label is delivered with every engine.</p> <ul style="list-style-type: none"> ▪ It should be mounted on the engine or machine in a clearly visible location. ▪ The maintenance intervals specified on the maintenance plan must be adhered to (see chapter 8.2.2 <i>Maintenance plan, page 54</i>)

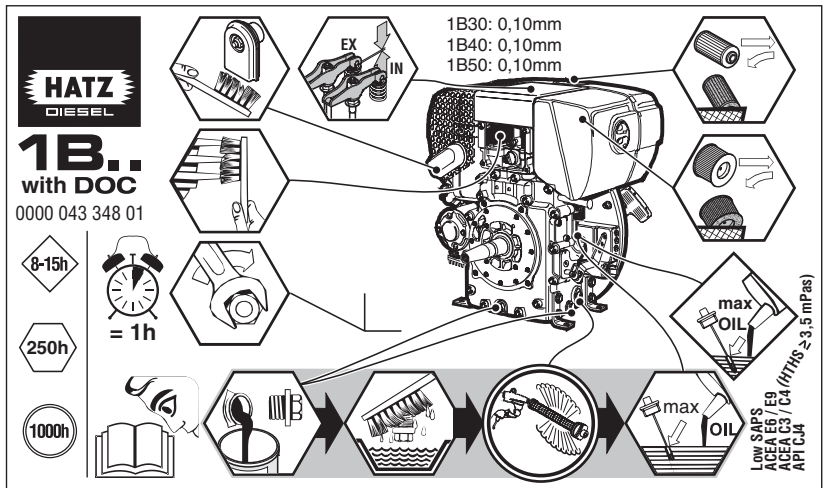

8.2.2 Maintenance plan



Daily checks

Symbol	Interval	Activity/check	Chapter
	Every 8–15 operating hours or every day before starting	Check the oil level	7.5 <i>Check the oil level, page 45</i>
		Check the intake area of the combustion air and cooling air	8.2.3 <i>Checking the intake area, page 57</i>
		Check the air filter maintenance indicator	7.8 <i>Check the air filter warning indicator (option), page 51</i>

Initial maintenance of new or rebuilt engines

Symbol	Maintenance interval	Maintenance step/check	Chapter
	After the first 25 operating hours	Change the engine oil.	8.2.4 <i>Change the engine oil, page 58</i>
		Check and set the tappet clearance.	8.2.6 <i>Checking and setting the tappet clearance, page 64</i>
		Check the screw connections.	8.2.8 <i>Check the screw connections, page 69</i>

Routine maintenance

Symbol	Maintenance interval	Maintenance step/check	Chapter
	Weekly	Checking the water separator	7.7 <i>Checking the water separator, page 49</i>
	Every 250 operating hours or every 12 months	Diagnosis of engine management ¹⁾²⁾ (to be performed by trained technicians)	
		Change the engine oil ²⁾	8.2.4 <i>Change the engine oil, page 58</i>
		Check and adjust the tappet clearance ²⁾	8.2.6 <i>Checking and setting the tappet clearance, page 64</i>
		Clean the cooling air area ²⁾	8.2.7 <i>Cleaning the cooling air area, page 66</i>
		Check the screw connections ²⁾	8.2.8 <i>Check the screw connections, page 69</i>
		Clean the exhaust screen ²⁾	8.2.9 <i>Clean the exhaust screen, page 69</i>
		Change the fuel prefilter and main fuel filter ²⁾³⁾	8.2.10 <i>Changing the fuel filter, page 71</i>
		Maintain the dry air filter ²⁾	8.2.11 <i>Maintaining the dry air filter, page 74</i>
	Every 500 operating hours	Clean the diesel particulate filter (DPF) ⁵⁾ (to be performed by trained technicians)	
	Every 1000 operating hours or every 4 years	Clean the oil filter ⁴⁾	8.2.5 <i>Clean the oil filter, page 61</i>
	Every 1500 operating hours	Change the diesel particulate filter (DPF)	





¹⁾ The engine control module continuously evaluates the engine-relevant data during operation. If an engine fault or deviations from the setpoints occur, these data are written to the error memory. Stored data can be read out and evaluated for fault diagnostics by a Hatz service partner using the Hatz Diagnostic Software HDS². In this way, faults can be detected and eliminated early on or preventative maintenance can be performed.

²⁾ Maintenance according to the maintenance interval or after 12 months, whichever comes first.

- ³⁾ The interval at which maintenance work should be performed on the fuel filter depends on the cleanliness of the fuel in use and may need to be shortened to 150 operating hours.
- 4) Maintenance according to the maintenance interval or after 4 years, whichever comes first
- ⁵⁾ Only for model with diesel particulate filter, see chap. 5 *Engine overview*, page 27. Hatz offers the **EasyClean** cleaning program for overhauling the diesel particulate filter.
For more information, see <https://parts.hatz.com/service/easyclean/>

8.2.3 Checking the intake area

Safety notes

 CAUTION	
 	<p>Danger of burns.</p> <p>There is a danger of burns when working on a hot engine.</p> <ul style="list-style-type: none"> ▪ Let the engine cool. ▪ Wear safety gloves.
NOTICE	
	<p>In case of heavy contamination, shorten the maintenance intervals accordingly (see chapter 8.2.2 <i>Maintenance plan, page 54</i>).</p>

Overview

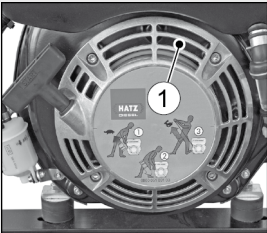
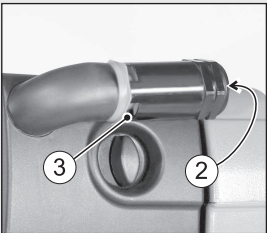
Standard	Model with cyclone precleaner
	
1	Air intake opening
2	Intake area of cyclone precleaner
3	Dust outlet opening

Procedure

Step	Activity
1	<p>Check the air intake opening (1) for coarse contamination such as leaves, heavy dust deposits, etc.</p> <p>Perform the following activities in case of heavy contamination:</p> <ul style="list-style-type: none"> ▪ Chap. 8.2.7 <i>Cleaning the cooling air area, page 66</i>. ▪ Chap. 8.2.11 <i>Maintaining the dry air filter, page 74</i>.









Step	Activity
2	In models with a cyclone precleaner , also check and if necessary clean the intake area (2) in addition to step 1. Check that the dust outlet opening (3) is clear and clean it if necessary.

8.2.4 Change the engine oil

This chapter contains the following subchapters:

- **Draining the engine oil**
- **Filling the engine oil**

Safety notes

 CAUTION	
 	<p>Danger of burns.</p> <p>When working on the engine, there is a danger of burns from hot oil.</p> <ul style="list-style-type: none"> ▪ Wear personal protective equipment (gloves).
 CAUTION	
	<p>Danger of environmental damage from spilled used oil.</p> <p>Used oil is water-polluting.</p> <ul style="list-style-type: none"> ▪ Do not allow them to enter the ground water, water bodies, or sewage system. ▪ Collect the used oil and dispose of it according to local environmental regulations.
 CAUTION	
 	<p>Danger of injury</p> <p>Prolonged contact with engine oil can lead to irritation of the skin.</p> <ul style="list-style-type: none"> ▪ Wear safety gloves. ▪ If there is contact with the skin, thoroughly wash the affected areas of the skin with soap and water.

CAUTION**Danger of later engine damage.**

- Operating the engine with an oil level below the **min.** mark or above the **max.** mark can lead to engine damage.
- When checking the oil level, the engine must be horizontal and have been switched off for a few minutes.

NOTICE

- The engine must be level.
- The engine must be switched off.
- Only drain engine oil while it is warm.

Draining the engine oil

Overview

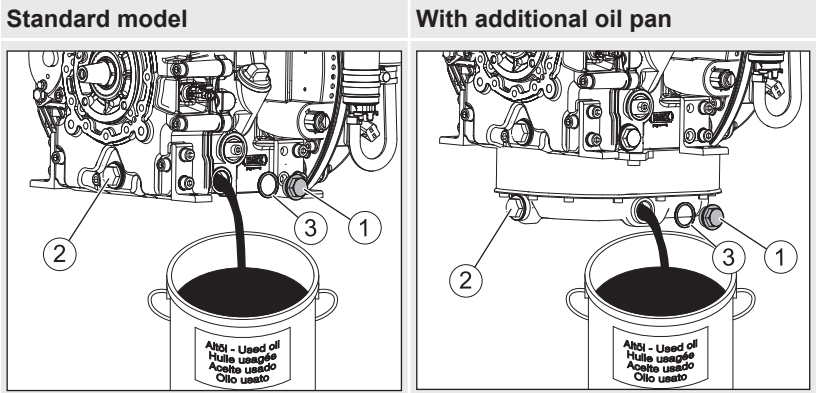

1	Oil drain screw (side)
2	Oil drain screw (front)
3	Seal ring

Procedure

Step	Activity
1	Keep a container ready for collecting the used oil. The container must be large enough to hold the entire amount of engine oil. For the engine oil capacity, see chapter 4.1 <i>Engine information and filling quantities</i> , page 21.
2	Depending on accessibility, the engine oil can be drained at oil drain screw (1) or (2). Unscrew the oil drain screw and drain the used oil entirely.
3	Screw in the cleaned oil drain screw with the new sealing ring and tighten. Tightening torque: 50 Nm.

Filling the engine oil

Overview

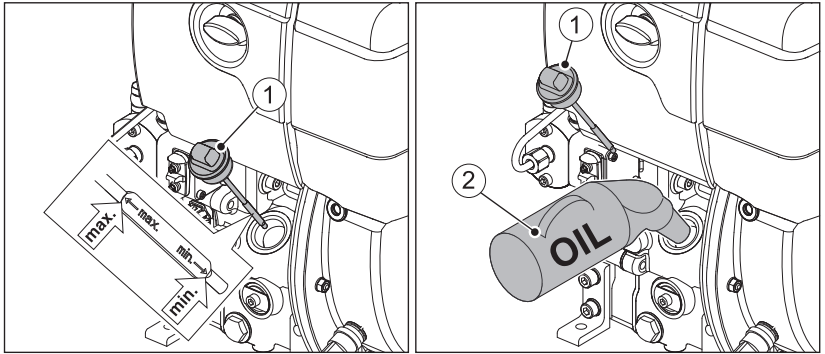



1	Dipstick
2	Oil refilling container

Procedure

Step	Activity
1	Unscrew the dipstick (1) and clean it.
2	Fill engine oil. For the specification and viscosity, see chapter 4.3 <i>Engine oil</i> , page 25. See chapter 4.1 <i>Engine information and filling quantities</i> , page 21 for the engine oil capacity.
3	Reinsert the dipstick and screw it tight.
4	Unscrew the dipstick and check the oil level.
5	If required, add engine oil to the max. mark.
6	Reinsert the dipstick and screw it tight.

8.2.5 Clean the oil filter

Safety notes

 CAUTION	
	<p>Danger of burns.</p> <p>There is a danger of burns when working on a hot engine.</p> <ul style="list-style-type: none"> Let the engine cool before maintenance.

 **CAUTION**
**Danger of injury**

Prolonged contact with engine oil can lead to irritation of the skin.



- Wear safety gloves.
- If there is contact with the skin, thoroughly wash the affected areas of the skin with soap and water.

 **CAUTION**
**Danger of injury.**

When working with compressed air, foreign bodies may fly into your eyes.



- Wear safety goggles.
- Never direct the compressed air jet toward people or toward yourself.

NOTICE



- Collect the emerging oil and dispose of it according to local environmental regulations.

NOTICE

- The oil filter should be cleaned when the engine oil is changed (see chapter 8.2.4 *Change the engine oil*, page 58), since oil will run out when the filter is pulled out.

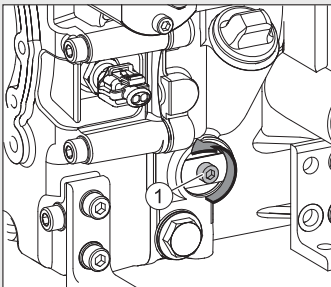

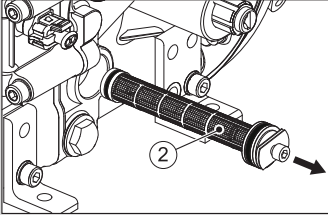

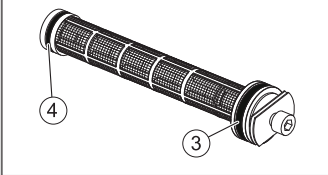
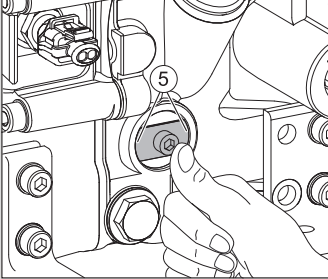
Procedure

Step	Activity	Figure
1	Loosen the screw (1) by approx. five turns.	

Step	Activity	Figure
2	Pull the oil filter (2) out of the housing.	
3	Blow out the oil filter from the inside to the outside with compressed air.	
4	Check the gaskets (3+4) for damage and renew if necessary.	
5	Lightly oil the gaskets before installation.	
6	Insert the oil filter and press it all the way in.	
7	Before tightening the screw, ensure that the tension springs (5) rest against the oil filter at both ends. Tighten the screw.	
8	Check the oil level and add oil to the max. mark if necessary (see chapter 7.5 <i>Check the oil level</i> , page 45).	

8.2.6 Checking and setting the tappet clearance

Safety notes

 CAUTION	
	<p>Danger of burns.</p> <p>There is a danger of burns when working on a hot engine. Only perform the settings while the engine is cold (10-30 °C).</p> <ul style="list-style-type: none"> Let the engine cool.
 CAUTION	
	<p>Damage from inadequate engine cooling.</p> <p>Only operate the engine when all covers are installed.</p>

Preparation

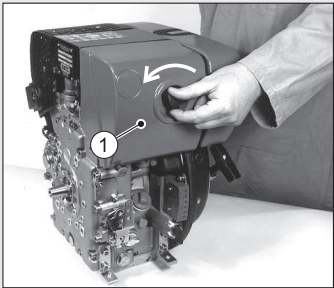
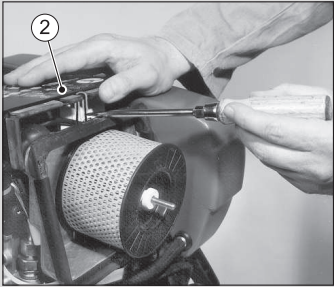
Step	Activity	Figure
1	Unscrew the air filter cover (1).	
2	Remove the sound protection hood (2).	



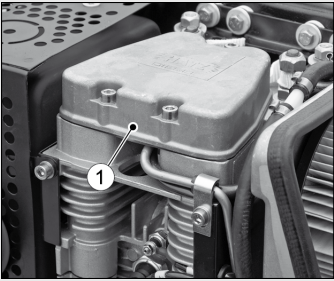
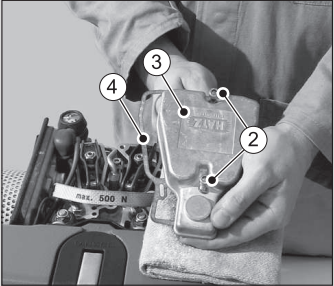
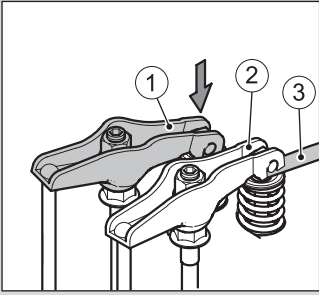

Procedure

Step	Activity	Figure
1	Remove dirt in the area of the cylinder head cover (1).	
2	Remove the screws (2). 2 screws in 1B30E, 3 screws in 1B50E.	
3	Take off the cover (3) with the gasket (4).	
4	Turn the engine in the sense of rotation until the rocker arm (1) has fully opened the outlet valve. Then check the tappet clearance at the rocker arm (2) with a feeler gauge (3). For the setting, see chapter 4.1 <i>Engine information and filling quantities</i> , page 21.	
5	Turn the engine in the sense of rotation until the rocker arm (2) has fully opened the intake valve. Now check the tappet clearance at the rocker arm (1).	

Step	Activity	Figure
6	<p>If the tappet clearance needs to be corrected:</p> <p>Release the screw (4) and turn the hex nut (5) so the feeler gauge (3) can be pulled through with a barely perceptible resistance after the screw (4) is tightened again.</p>	
7	Mount the cylinder head cover with the new gasket and tighten evenly.	
8	Fully assemble the engine.	
9	Perform a test run. Check the cylinder head cover for tightness.	

8.2.7 Cleaning the cooling air area

Safety notes



 CAUTION	
	<p>Danger of burns.</p> <p>There is a danger of burns when working on a hot engine.</p> <ul style="list-style-type: none"> Let the engine cool before maintenance.
 CAUTION	
 	<p>Danger of injury.</p> <p>When working with compressed air, foreign bodies may fly into your eyes.</p> <ul style="list-style-type: none"> Wear safety goggles. Never direct the compressed air jet toward people or toward yourself.



CAUTION

Danger of damage to the machine from incorrect engine cleaning.

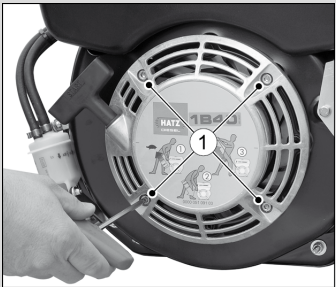
- Let the engine fully cool down before cleaning.
- Do not spray components of the electrical equipment with a water jet or high pressure jet during cleaning.

Procedure

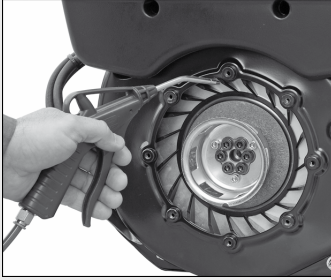
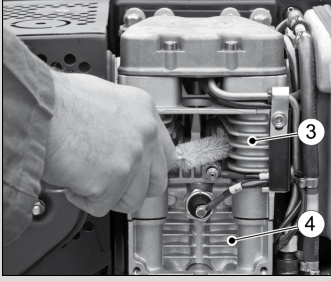
Step	Activity	Figure
Dry contamination		
1	Remove the screws (1).	
2	Take off the recoil start (2) and clean it.	
3	Clean the fan blades with a suitable brush.	

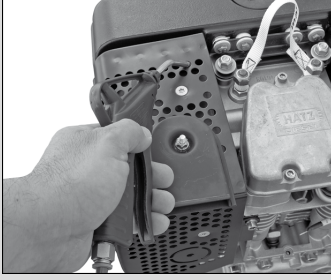
Step	Activity	Figure
4	Then blow it out with compressed air.	
5	Also clean the cooling ribs of the cylinder head (3) and cylinder (4) and blow out with compressed air.	
6	Check the air gap (5) for dirt and clean with compressed air if necessary.	
7	The element can be checked and cleaned through the holes in the contact guard.	
8	Mount the recoil start (2) again.	

Step	Activity	Figure
Moist or oily contamination		
1	Contact HATZ service.	

8.2.8 Check the screw connections

Safety note





NOTICE	
	<ul style="list-style-type: none"> Do not retighten the screws for attaching the cylinder head. Only retighten loose screw connections. Screw connections can be secured with thread locking adhesive or tightened to a defined torque. Retightening tight screw connections can cause damage.

Procedure

Step	Activity
1	Check the condition of all screw connections and ensure that they are tight (for exceptions, see note).
2	Tighten any lose screw connections.

8.2.9 Clean the exhaust screen

Safety notes

 CAUTION	
	<p>Danger of burns.</p> <p>There is a danger of burns when working on a hot engine.</p> <ul style="list-style-type: none"> Let the engine cool before maintenance.
 CAUTION	
 	<p>Danger of injury</p> <p>There is a danger of injury when performing cleaning work at the exhaust screen.</p> <ul style="list-style-type: none"> Wear safety gloves.

Procedure

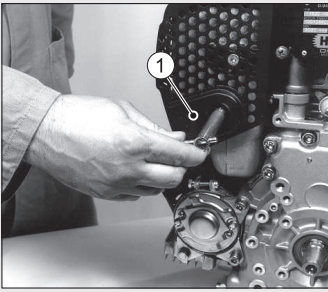
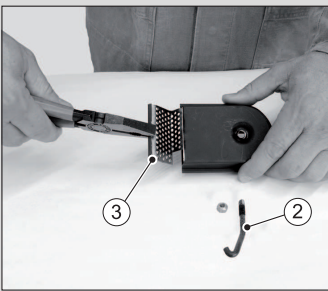
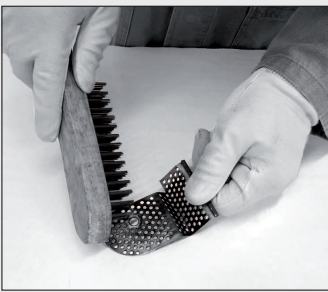
Step	Activity	Figure
1	Release the hex nut and take off the exhaust manifold (1).	
2	Remove the hex nut from the bracket (2) and pull out the screen insert (3).	
3	Remove the deposits in the screen insert with a suitable wire brush.	
4	Check the screen insert for cracks or breakage, and replace if necessary.	
5	Mount the screen insert and bracket again.	

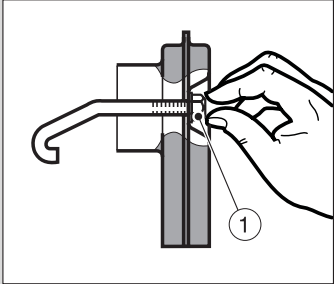
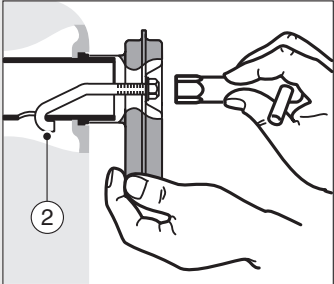

Step	Activity	Figure
6	Tighten the hex nut (1) by approx. one turn.	
7	Insert the exhaust manifold with the bracket (2) into the hole and pull it back to the outside so that the bracket can no longer become unhooked.	
8	Tighten the hex nut.	

8.2.10 Changing the fuel filter

This chapter contains the following subchapters:

- **Changing the fuel prefilter**
- **Changing the main fuel filter**

Safety notes

 DANGER	
 	<p>Fire hazard from fuel</p> <p>Leaked or spilled fuel can ignite on hot engine parts and cause serious burn injuries.</p> <ul style="list-style-type: none"> ▪ Do not spill fuel. ▪ No open flames when working on the fuel system. ▪ Do not smoke.

**CAUTION****Danger of injury.**

Repeated contact with diesel fuel can cause chapped and cracked skin.



- Wear safety gloves.
- If there is contact with the skin, thoroughly wash the affected areas of the skin with soap and water.

**CAUTION****Danger of environmental damage from spilled fuel.**

When the filter is removed, a small amount of fuel is drained as well.

- Collect any escaping fuel and dispose of it according to local environmental regulations.

CAUTION**Dirt particles can damage the injection system.**

- Maintain clean conditions to ensure dirt does not enter the fuel line.

Changing the fuel prefilter**Procedure**

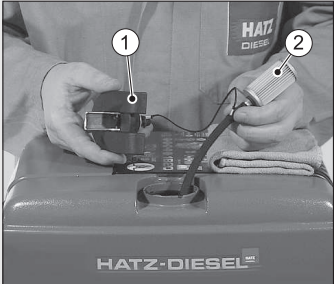
Step	Activity	Figure
1	Open the fuel cap (1) and pull the fuel prefilter (2) out of the tank by the cord.	

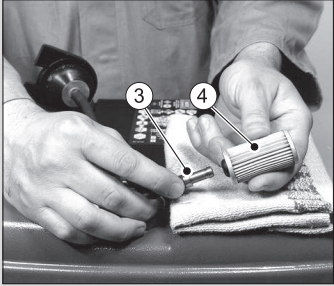
Step	Activity	Figure
2	Pull the fuel feed line (3) off of the fuel prefilter (4) and insert a new filter.	
3	Insert the fuel prefilter back into the tank.	
4	Close the fuel cap.	
5	Bleed the fuel system (see chapter 6.5 <i>Venting the fuel system</i> , page 37).	

Changing the main fuel filter

Overview

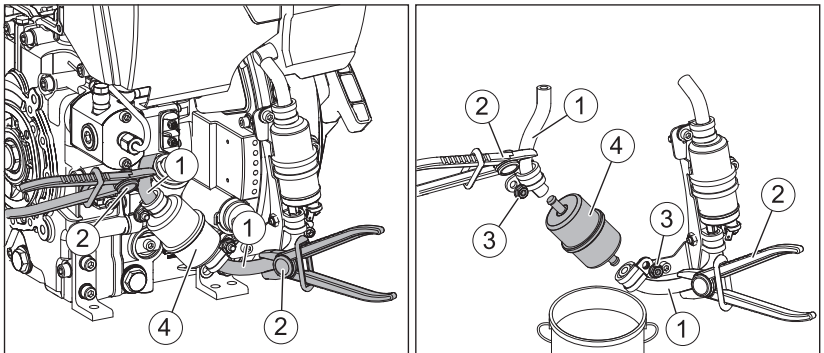

1	Fuel feed line
2	Hose clip
3	Hexagon nut
4	Main fuel filter

Procedure

Step	Activity
1	Block the fuel supply line (1) upstream and downstream of the main fuel filter (4) using hose clips (2).

Step	Activity
2	Place a suitable container under the main fuel filter (4) to collect emerging fuel.
3	Unscrew the hexagon nuts (3).
4	Pull off the fuel supply line (1) on both sides of the main fuel filter (4). Dispose of the main fuel filter according to the local environmental regulations.
5	Insert a new main fuel filter. Observe the flow-through direction (arrows).
6	Attach the main fuel filter to the holder using hexagon nuts (3) and then release the fuel supply line again for use.
7	Bleed the fuel system (see chapter 6.5 <i>Venting the fuel system, page 37</i>).
8	Start the engine and perform a test run.
9	After test run, check the fuel filter for leak tightness.

8.2.11 Maintaining the dry air filter



NOTICE



- Immediately clean the filter cartridge if the maintenance display appears at maximum speed.
- Always renew the filter cartridge after a use period of 250 operating hours.



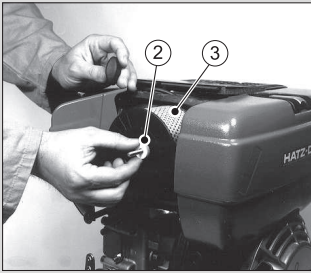
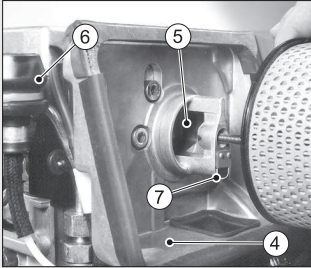

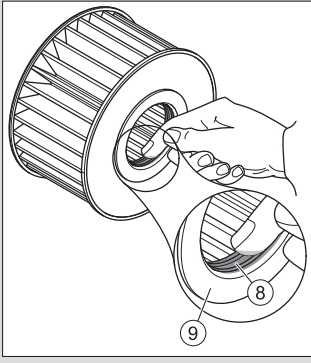

Installing and removing the filter cartridge

Step	Activity	Figure
1	Unscrew the air filter cover (1).	

Step	Activity	Figure
2	Unscrew the knurled nut (2) and remove the air filter cartridge (3).	
3	Clean the filter housing (4) and cover for the air filter. Ingress of dirt or other foreign bodies into the intake opening (5) of the engine absolutely must be avoided.	
4	In the model with an air filter maintenance display (6), check the condition and cleanliness of the valve shim (7).	
5	The air filter cartridge either needs to be replaced, or cleaned or checked depending on the degree of contamination (see chapter 8.2.12 <i>Checking and cleaning the air filter cartridge</i> , page 76).	
6	Thinly coat the gasket (8) with grease or engine oil to make assembly and disassembly of the air filter cartridge easier. Do not coat the face side (9).	
7	Assemble in reverse order.	

8.2.12 Checking and cleaning the air filter cartridge

Safety notes

 CAUTION	
 	<p>Danger of injury.</p> <p>When working with compressed air, foreign bodies may fly into your eyes.</p> <ul style="list-style-type: none"> ▪ Wear safety goggles. ▪ Never direct the compressed air jet toward people or toward yourself.
 CAUTION	
	<p>Danger of injury.</p> <p>When blowing out the filter cartridge, the ambient air becomes contaminated with dust.</p> <ul style="list-style-type: none"> ▪ This dust may contain harmful particles. ▪ Wear a fine dust mask.
NOTICE	
	<ul style="list-style-type: none"> ▪ The pressure must not exceed 5 bar. ▪ Even minor damage in the areas of the sealing surface, filter paper or filter cartridge makes it impossible to reuse the filter cartridge.

Checking and cleaning the air filter cartridge

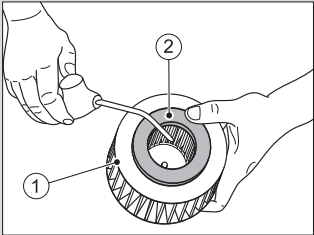
Step	Activity	Figure
Dry contamination		
1	Blow out the filter cartridge (1) with dry compressed air from the inside to the outside until dust no longer emerges.	
2	Check the sealing surface (2) of the filter cartridge for damage.	
3	Check the filter cartridge for cracks in the filter paper and other damage by holding it against the light at a slant or letting light from a lamp shine through it.	
4	Replace the filter cartridge if necessary (see note).	
Moist or oily contamination		
1	Renew the filter cartridge.	

9 Faults

9.1 Troubleshooting

General troubleshooting notes

If the cases listed below have been worked through but the fault continues to persist, please contact your nearest **Hatz service station**.

The engine fault indicator on the HATZ instrument box lights up during operation.

Possible causes	Remedy	Chapter
Various errors in different assemblies.	Use the flash code table to identify and eliminate errors.	<i>9.2 Flash code table for engine faults, page 81</i>

The engine does not start or is difficult to start, but can be turned easily as usual

Possible causes	Remedy	Chapter
The tank ran out of fuel during operation.	Add fuel.	<i>7.6 Refueling, page 47</i>
Fuel filter is clogged.	Change the fuel filter.	<i>8.2.10 Changing the fuel filter, page 71</i>
Electrical fuel pump is not working.	Check the cabling.	
Injection nozzle is not functional.	Contact HATZ service.	
Insufficient compression:		
<ul style="list-style-type: none"> ▪ Wrong tappet clearance. 	Check the tappet clearance and adjust if necessary.	<i>8.2.6 Checking and setting the tappet clearance, page 64</i>
<ul style="list-style-type: none"> ▪ Cylinder and/or piston ring wear. 	Contact HATZ service.	

At low temperatures (engine does not start)

Possible causes	Remedy	Chapter
Pre glow system (option) defective.	Contact HATZ service.	
Fuel gelled due to insufficient cold resistance.	Check whether the fuel that emerges from the fuel feed line is clear and not cloudy. If the fuel has gelled, either thaw the engine or drain the entire fuel supply system, and change the fuel filter. Fill with a temperature-resistant fuel mixture.	4.4 <i>Fuel</i> , page 26 8.2.10 <i>Changing the fuel filter</i> , page 71
Oil is too viscous and causes a too low starter speed.	Change the engine oil. Add engine oil with a suitable viscosity class.	8.2.4 <i>Change the engine oil</i> , page 58
Insufficiently charged battery.	Check the battery and contact the service center if necessary.	3.2.4 <i>Electrical equipment</i> , page 18
Machine is not uncoupled.	If possible, separate the engine from the machine by uncoupling it.	

The starter does not switch on and the engine does not turn.

Possible causes	Remedy	Chapter
Irregularities in the electrical equipment:		
Battery and/or other cable connections are incorrectly connected.	Check the electrical equipment and its components or contact Hatz service.	3.2.4 <i>Electrical equipment</i> , page 18
Cable connections are loose and/or oxidized.		
Battery is defective and/or not loaded.		
Defective starter.		
Defective relay, monitoring elements etc.		

Engine switches off spontaneously during operation

Possible causes	Remedy	Chapter
Engine malfunction (indicator for engine malfunction flashes).	Use the flash code table to identify and eliminate errors.	<i>9.2 Flash code table for engine faults, page 81</i>
The tank ran out of fuel during operation.	Fill with fuel.	<i>7.6 Refueling, page 47</i>
Fuel filter is clogged.	Change the fuel filter.	<i>8.2.10 Changing the fuel filter, page 71</i>
Tank vent is clogged.	Ensure that the tank is sufficiently vented.	
Electrical defects.	Check the wiring or contact HATZ service.	
Mechanical faults.	Contact HATZ service.	

The engine loses power and speed

Possible causes	Remedy	Chapter
<ul style="list-style-type: none"> ▪ The engine is running in emergency mode due to a malfunction (engine malfunction indicator is lit) 	Switch off the engine and use the flash code table to identify and eliminate errors.	<i>9.2 Flash code table for engine faults, page 81</i>
<ul style="list-style-type: none"> ▪ The tank ran out of fuel during operation. 	Add fuel.	<i>7.6 Refueling, page 47</i>
<ul style="list-style-type: none"> ▪ Fuel filter is clogged. 	Change the fuel filter.	<i>8.2.10 Changing the fuel filter, page 71</i>
<ul style="list-style-type: none"> ▪ Inadequate tank venting. 	Ensure that the tank is sufficiently vented.	

The engine loses power and speed, and black smoke emerges from the exhaust

Possible causes	Remedy	Chapter
Dirty air filter unit.	Check the degree of dirt contamination of the air filter, and clean or renew if necessary.	<i>8.2.11 Maintaining the dry air filter, page 74</i>

Possible causes	Remedy	Chapter
Tappet clearance not OK.	Adjust the tappet clearance.	8.2.6 <i>Checking and setting the tappet clearance, page 64</i>
Injection nozzle not OK.	Contact HATZ Service.	

The engine is unexpectedly running at a low speed. It is not possible to increase the engine speed.

Possible causes	Remedy	Chapter
Engine malfunction (indicator for engine malfunction is lit).	Use the flash code table to identify and eliminate errors.	9.2 <i>Flash code table for engine faults, page 81</i>

Engine becomes very hot. Indicator lamp for engine temperature (option) lights up

Possible causes	Remedy	Chapter
Too much engine oil in the engine.	Drain the engine oil to the upper mark of the dipstick.	7.5 <i>Check the oil level, page 45</i>
Inadequate cooling:		
<ul style="list-style-type: none"> ▪ Contamination in the entire area of the cooling air guides. 	Clean the cooling air area.	8.2.7 <i>Cleaning the cooling air area, page 66</i>
<ul style="list-style-type: none"> ▪ Incompletely closed air guide parts. 	Check the air guide parts and shafts for completeness and good sealing properties.	

Condensate emerges from the exhaust silencer

Possible causes	Remedy	Chapter
Operation under no load or very low load for an extended period.	Operate the machine at a load of approx. 70 % if possible until the exhaust outlet is dry again.	

9.2 Flash code table for engine faults

If an engine malfunction occurs, the indicator for "Engine malfunction" lights up (see *Explanation of symbols, chapter 5.2 HATZ instrument box, page 30*). If the engine is switched off and the starting key is set to "I", a flashing signal is output on the engine control indicator. The table below shows possible flashing signals, their meaning, as well as measures for remedies. If the listed fault cases have been worked through but the fault continues to persist, please contact your nearest **HATZ Service**.

The diagrams show the structure of a flash code using flash codes 2 and 3 as examples:

Flash code 2

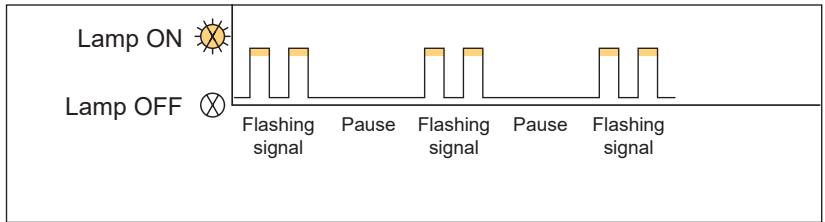

Flash code 3

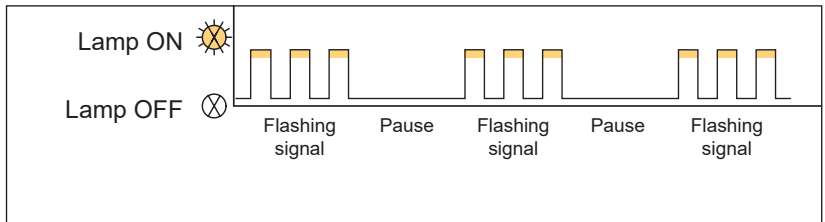

The light flashes three times in a row for each error. If two or more errors are active, these are flashed immediately afterwards. To repeat, turn the starting key to position "0" and then back to position "I". The flash code is deleted automatically if the error does not reoccur within two operating cycles (= start/operation/stop).

Flash code table

Flashing signal	Possible causes	Remedy	Chapter
1 <i>Area affected:</i> Engine oil pressure	Engine oil pressure too low.	Check the oil level.	<i>7.5 Check the oil level, page 45</i>
2 <i>Area affected:</i> Overtemperature	Engine temperature is too high.	Clean the cooling air area.	<i>8.2.7 Cleaning the cooling air area, page 66</i>
	Oil temperature too high.	Reduce the engine load.	

Flashing signal	Possible causes	Remedy	Chapter
3 <i>Affected area:</i> Charge control	Faulty voltage controller.	Contact HATZ service.	
	Battery voltage too high.	Contact HATZ service.	
	Battery voltage too low.	Check the electrical equipment and its components or contact Hatz service.	
	Speed adjustment is faulty.	Contact HATZ service.	
	Supply voltage for sensors is faulty.	Check the cabling.	
4 <i>Area affected:</i> Analog setpoint or CAN communication	Cabling is faulty.	Check the cabling.	
	Speed adjustment is faulty.	Contact HATZ service.	
5 <i>Area affected:</i> Ambient pressure sensor	Sensor is faulty.	Contact HATZ service.	
7 <i>Area affected:</i> Fuel pump, glow plug, injection pump	Cabling is faulty.	Check the cabling.	
	Fuel pump, glow plug or injection pump is faulty.	Contact HATZ service.	
8 <i>Area affected:</i> Speed sensor system	Cabling to the crankshaft speed sensor is faulty.	Check the cabling.	
	Crankshaft speed sensor is faulty.	Contact HATZ service.	
	Engine speed is impermissibly high.	Contact HATZ service.	

Flashing signal	Possible causes	Remedy	Chapter
9 <i>Area affected:</i> Control unit	Cabling to the control unit is faulty.	Check the cabling.	
	Faulty control unit.	Contact HATZ service.	





9.3 Emergency hand start

The series engine is equipped with an electric start mechanism. An emergency hand start system that can be used to start the equipment by hand can be installed additionally as an option. An emergency hand start should only be performed if an electric start is not possible, e.g. when the battery is weak.

This chapter contains the following subchapters:

- **Safety notes**
- **Prerequisite for performing an emergency hand start**
- **Performing tests**
- **Emergency hand start with recoil start**

Safety notes

 DANGER	
	<p>Danger to life from inhaling exhaust gases.</p> <p>Toxic engine exhaust gases can lead to loss of consciousness, and even death, in closed-off and poorly ventilated rooms.</p> <ul style="list-style-type: none"> ▪ Never operate the machine in closed-off or poorly ventilated rooms. ▪ Do not breathe in the exhaust gases.
 WARNING	
	<p>Danger of injury from faulty starter rope.</p> <p>A chafed starter rope can rip and cause injuries.</p> <ul style="list-style-type: none"> ▪ Before using the starter rope, check for abrasion; replace the rope if necessary.

**CAUTION****Danger of injury from the use of starting fluid.**

- Danger of injury during emergency hand start because the use of starting fluid can result in uncontrolled ignitions.
- Never use starting fluid.

Prerequisite for performing an emergency hand start

- The battery has enough residual voltage left that the charge control, oil pressure indicator and engine fault indicator light up in starting key position I (operation) (see also chapter 5.2 *HATZ instrument box*, page 30).
- The operator must have a powerful build and must not have any medical restrictions. The emergency hand start system may not be operated by children or by people with a less powerful build.
- Wear safety shoes and closed work clothing (see chapter *Personal protective equipment*, chapter 3.2.1 *Operational safety*, page 12).
- Ambient temperature: 5 °C or higher

NOTICE**An emergency hand start is not possible if the fuel tank is empty.**

If the fuel tank has been run empty, the fuel system will need to be bled after being refilled using the electric fuel pump (see chapter 6.5 *Venting the fuel system*, page 37).

After bleeding, multiple start attempts with the starter are necessary to start the engine.

Performing tests

Procedure

Step	Test
1	The machine is standing securely and on a level surface.
2	The installation location is adequately ventilated.
3	There is a sufficient amount of fuel in the fuel tank (see chapter 7.6 <i>Refueling</i> , page 47).
4	There is a sufficient amount of engine oil in the engine housing (see chapter 6.4 <i>Filling engine oil (first filling)</i> , page 36).
5	Starter rope of the recoil start without chafing.
6	No persons are located in the danger zone of the engine or machine.
7	All safety equipment is in place.

Emergency hand start with recoil start

Overview

Standard (instrument box attached on the engine)

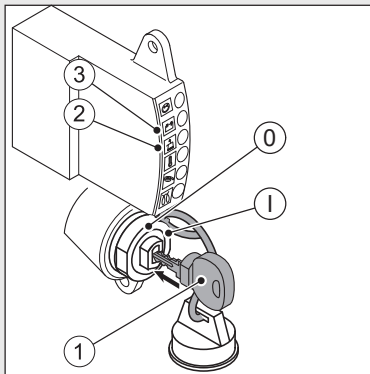

Option (external instrument box)

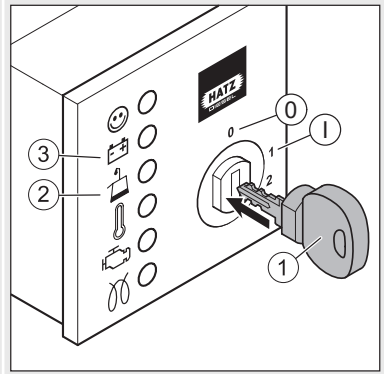

1	Starting key
2	Oil pressure indicator
3	Charge control
Ignition lock	
0	Off
1	Operation

Recoil start

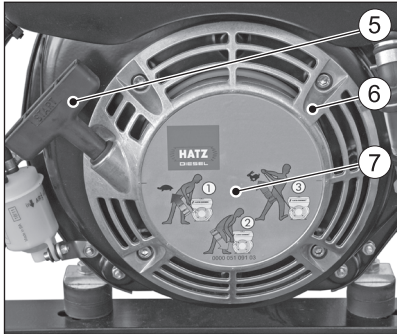

5	Grip
6	Recoil start cover
7	Diagram of starting procedure

Procedure











Step	Activity
1	Insert the starting key (1) all the way and turn to position "I". The oil pressure indicator and charge control light up.
2	Assume a sturdy position. The surface you are standing on must not be slippery.
3	Secure lightweight devices with your foot.
4	Pull the grip (5) with the rope through slowly and let it run back in. This activates the electric fuel pump for 10 seconds. If the engine does not start within these 10 seconds, repeat the procedure.
5	Slowly pull out the grip (5) with the rope until you encounter slight resistance.
6	Let the rope run back in to be able to use the entire rope length for the starting procedure.
7	Hold the grip with both hands.
8	<p>Pull the starting rope evenly and with increasing speed (do not tear at it jerkily) until the engine starts.</p> <p><i>Note:</i> If the engine does not start, the starting process can be repeated by performing steps 2–8.</p>
9	The oil pressure indicator and charge control must go out after the engine is started.

10 Storage and disposal

10.1 Storing the machine

Safety notes

 DANGER	
	<p>Danger to life from inhaling exhaust gases.</p> <p>Toxic engine exhaust gases can lead to loss of consciousness, and even death, in closed-off and poorly ventilated rooms.</p> <ul style="list-style-type: none"> ▪ Never operate the machine in closed-off or poorly ventilated rooms. ▪ Do not breathe in the exhaust gases.
 DANGER	
 	<p>Fire hazard from fuel.</p> <p>Leaked or spilled fuel can ignite on hot engine parts and cause serious burn injuries.</p> <ul style="list-style-type: none"> ▪ Only refuel when the engine is switched off and has cooled down. ▪ Never refuel in the vicinity of open flames or sparks that can cause ignition. ▪ Do not smoke. ▪ Do not spill fuel.
 CAUTION	
	<p>Danger of environmental damage from spilled fuel.</p> <p>Do not overfill the fuel tank and do not spill fuel.</p> <ul style="list-style-type: none"> ▪ Collect any leaking fuel and dispose of it according to local environmental regulations.
NOTICE	
	<p>Comply with the safety chapter!</p> <p>Follow the basic safety instructions in chapter 3 <i>Safety</i>, page 7.</p>

Storing the machine for a lengthy period

Take the following measures if you intend to take the machine out of service for a lengthy period (3-12 months):

Step	Activity
1	Drain the fuel tank until it is nearly empty and fill with FAME*-free fuel. Operate the engine for a few minutes so that only FAME-free fuel is still in the fuel system.
2	Change the engine oil (see chapter 8.2.4 <i>Change the engine oil, page 58</i>).
3	Change the fuel filter (see chapter 8.2.10 <i>Changing the fuel filter, page 71</i>).
4	Let the machine cool down.
5	Remove the battery in accordance with the Operator's Manual for the machine and store at ambient temperature. Comply with the local regulations as well as the regulations of the battery manufacturer for the storage of batteries.
6	Close and seal all engine openings (air intake openings, air outlet openings and the exhaust gas opening) so that no foreign bodies can enter, but a small amount of air can still be exchanged. This avoids condensation.
7	After the machine has cooled down, cover it to protect it against dust, and store it in a dry and clean place.

*FAME = Fatty Acid Methyl Ester

Ambient conditions during storage

- Max. permissible storage temperature: -25 °C to +60 °C
- Max. permissible humidity: 70%
- Protect the engine from direct sunlight

Recommissioning

Step	Activity
1	Remove all covers.
2	Check the cables, hoses and lines for cracks and leak tightness.
3	Check the engine oil level.
4	Install the battery in accordance with the Operator's Manual for the machine.

The brand new engine can normally be stored for up to 12 months. The protection lasts up to approx. 6 months at very high humidity and in sea air.

For storage periods of more than 12 months, please contact the nearest **HATZ Service**.

10.2 Disposing of the machine

Disposal information

Dispose of the machine (including machine parts, engine oil and fuel) according to the local disposal regulations and the environmental laws in the country of use.

Because of the danger of possible environmental damage, only permit an approved specialist company to dispose of the machine.

NOTICE



When the machine has reached the end of its lifecycle, ensure that it is disposed of safely and properly, especially parts and substances that can be dangerous to the environment. These also include fuel, lubricants, plastics, and batteries (if present).

- Do not dispose of the battery with the household trash.
- Dispose of the battery at a collection point for possible recycling.

11 Proof of quality

Proof of quality

The manufacturer: **Motorenfabrik Hatz GmbH & Co.KG**
Ernst-Hatz-Straße 16
D-94099 Ruhstorf a. d. Rott

hereby declares that the incomplete machine: product description: **Hatz diesel engine**
Type designation and as of serial number:

1B30E=18204;
1B50E=18405

satisfies the following basic safety and health protection requirements in acc. with Annex I of the EC Machinery Directive 2006/42/EC.

- Annex I, General principles no. 1

- Nr. 1.1.2., 1.1.3., 1.1.5., 1.2.1., 1.2.2., 1.2.3., 1.2.4.1., 1.2.4.2., 1.3.1., 1.3.2., 1.3.3., 1.3.4.,
1.3.7., 1.3.9., 1.4.1., 1.5.1., 1.5.3., 1.5.8., 1.5.9., 1.6.1., 1.6.2., 1.6.4., 1.7.

All relevant basic safety and health protection requirements down to the interfaces described

- in the manual for diesel engine
- in the enclosed data sheets
- in the enclosed technical documents

have been complied with.

The special technical documents in acc. with Annex VII B of the Directive 2006/42/EC have been prepared.

The following standards have been used (completely or partially):

- EN 1679-1: 092011 - EN ISO 12100: 032011 - EN ISO 13857: 062008
- EN 60204-1: 062007

The manual for diesel engine has been enclosed to the incomplete machine and the Assembly Instructions have been provided to the customer electronically together with the order confirmation.

Commissioning has been prohibited until it has been established, if applicable, that the machine into which the above-mentioned incomplete machine is to be incorporated, satisfies the provisions of the respective federal state.

12 EPA AND CARB CERTIFIED ENGINES

**SUPPLEMENTAL INFORMATION
TO THE OWNER'S MANUAL FOR MODEL YEAR 2024
FOR EPA AND CALIFORNIA CERTIFIED NONROAD
COMPRESSION IGNITION ENGINES.**

**EPA AND CALIFORNIA EMISSION CONTROL
SUPPLEMENTAL WARRANTY STATEMENT.**

EPA AND CARB EMISSION CONTROL WARRANTY STATEMENT.

YOUR WARRANTY RIGHTS AND OBLIGATIONS.

The California Air Resources Board and Motorenfabrik Hatz GmbH & Co. KG is pleased to explain the emission control system warranty on your Model Year 2024 engine. In California, new heavy-duty off-road engines must be designed, built, and equipped to meet the State's stringent anti-smog standards. The Motorenfabrik Hatz GmbH & Co. KG must warrant the emission control system on your engine for the periods of time listed below provided there has been no abuse, neglect or improper maintenance of your engine.

Where a warrantable condition exists, the Motorenfabrik Hatz GmbH & Co. KG will repair your heavy-duty off-road engine at no cost to you including diagnosis, parts, and labor.

MANUFACTURER'S WARRANTY COVERAGE.

The Model Year 2024 heavy-duty off-road engines are warranted for the periods described below. Motorenfabrik Hatz GmbH & Co. KG warrants to the original owner, and to each subsequent owner, of a new, diesel engine that the emission control system of your engine:

- Was designed, built and equipped so as to conform at the time of sale with all applicable regulations of the California Air Resources Board (CARB).
- Is free from defects in material and workmanship that will cause such engine to fail to conform with applicable regulations for the following warranty period:

If your engine is certified as . . .	And its maximum power is . . .	And its rated speed is . . .	Then its warranty period is . . .
Variable speed or constant speed	kW <19 (25 HP)	Any speed	1.500 hours or two years, whichever comes first.
Constant speed	19 ≤ kW <37 (25 ≥ HP <50)	3.000 rpm or higher	1.500 hours or two years, whichever comes first.
Constant speed	19 ≤ kW <37 (50 ≥ HP <50)	Less than 3.000 rpm	3.000 hours or five years, whichever comes first.
Variable speed	19 ≤ kW <37 (50 ≥ HP <50)	Any speed	3.000 hours or five years, whichever comes first.
Variable speed or constant speed	kW ≥37 (>50 HP)	Any speed	3.000 hours or five years, whichever comes first.

If any emission-related part on your engine is defective, the part will be repaired or re-placed by Motorenfabrik Hatz GmbH & Co. KG.

The warranty period shall begin:

- on the date the equipment is first delivered to the first retail purchaser, or;
- if the equipment is placed in service for demonstration purposes prior to sale at retail, on the date the engine is first placed in service.

The emission control systems of your new Motorenfabrik Hatz engine was designed, built and tested using genuine Motorenfabrik Hatz parts, and the engine is certified as being in conformity with CARB and US EPA emission control regulations. Accordingly, it is recommended that any replacement parts used for maintenance, repair or replacement of emission control systems be Motorenfabrik Hatz parts. Any replacement part that is equivalent in all material respects may be used in the performance of any maintenance or repairs, although Motorenfabrik Hatz recommends that the owner obtain assurance that such parts are warranted by their manufacturer to be equivalent to genuine Motorenfabrik Hatz GmbH & Co. KG parts. Such use shall not reduce the remaining warranty obligations of the engine manufacturer, provided they are warranted to be equivalent to genuine Motorenfabrik Hatz parts.

Any warranted part that is not scheduled for replacement, as required maintenance shall be warranted for the warranty period defined above. If any such part fails during the period of warranty coverage, it will be repaired or replaced under warranty. Any such part repaired or replaced under the warranty shall be warranted for the remaining warranty period.

Any warranted part that is scheduled only for regular inspection in the written instructions shall be warranted for the warranty period defined above. A statement in the written instructions to the effect of "repair or replace as necessary" shall not reduce the period of warranty coverage. Any such part repaired or replaced under warranty shall be warranted for the remaining warranty period.

Any warranted part that is scheduled for replacement, as required maintenance shall be warranted for the period of time prior to the first scheduled replacement point for that part. If the part fails prior to the first scheduled replacement, the part shall be repaired or replaced by the engine manufacturer under warranty. Any such part repaired or replaced under warranty shall be warranted for the remainder of the period prior to the first scheduled replacement point for the part.

Repair or replacement of any warranted part under warranty shall be performed at no charge to the owner at a warranty station.

Motorenfabrik Hatz provides warranty services or repairs at all manufacturer distribution centers (warranty stations) that are franchised to service the subject engines. Please see the Customer Assistance section of this statement for help in locating such service centers.

The owner will not be charged for diagnostic labor that leads to the determination that a warranted part is in fact defective, provided that such diagnostic work is performed at a warranty station.

Motorenfabrik Hatz is liable for damages to other engine components proximately caused by a failure under warranty of any warranted part.

OWNER'S WARRANTY RESPONSIBILITIES.

As the engine owner, you are responsible for the performance of the required maintenance listed in your owner's manual. Motorenfabrik Hatz recommends that you retain all receipts covering maintenance on your engine, but Motorenfabrik Hatz cannot deny warranty solely for the lack of receipts or for your failure to ensure the performance of all scheduled maintenance.

As the engine owner, you should be aware, however, that Motorenfabrik Hatz may deny you warranty coverage if your engine or a part has failed due to abuse, neglect, improper maintenance or unapproved modifications.

Your engine is designed to operate ultra-low sulfur fuel only. Use of any other fuel may result in your engine no longer operating in compliance with California's emissions requirements.

You are responsible for presenting your engine to a Motorenfabrik Hatz authorized service center as soon as a problem exists. The warranty repairs should be completed in a reasonable amount of time, not to exceed 30 days.

Add-on or modified parts, as defined in CCFR Section 1900(b)(1) and (b) (10), Title 13, that are not exempted by the Air Resources Board may not be used. The use of any non-exempted add-on or modified parts shall be grounds for disallowing a warranty claim made in accordance with this article. The engine manufacturer shall not be liable under this article to warrant failures of warranted parts caused by the use of a non-exempted add-on or modified part.

Customer Assistance

If you have any questions regarding your warranty rights and responsibilities, you should contact HATZ DIESEL OF AMERICA, Inc. at (262)-544-0254.

What is Not Covered by the Emission Warranty

Please note that Emission Warranty does not cover:

- Systems and parts that were not first installed on the new equipment or engine as original equipment by Motorenfabrik Hatz.
- Part malfunctions caused by abuse, misuse, improper adjustment, modification, alteration, tampering, disconnection, improper or inadequate maintenance, or use of non-recommended fuels and lubricating oils.
- Damage caused by accident, acts of nature, or other events beyond Motorenfabrik Hatz's control.
- Replacement of expendable items made in connection with scheduled maintenance.
- Parts requiring replacement, inspection or adjustment during scheduled maintenance intervals where the part is not defective.
- Parts that are not Motorenfabrik Hatz Service Parts.
- Loss of time, inconvenience, loss of use of equipment/engine or commercial loss.

- Equipment with an altered or disconnected hourmeter where the hours cannot be determined. Equipment normally operated outside the United States.
- Non-defective parts replaced by other than Motorenfabrik Hatz dealers.

What is Covered by the Emission Warranty

The following is a list of systems and parts that are considered a part of the Emission Control System and are covered by the Emission Warranty for engines that were built to conform to EPA and CARB regulations:

IMPORTANT!

This may not include expendable maintenance items. Emission related parts requiring scheduled maintenance are warranted until their first scheduled replacement point only.

The following parts as manufactured according to HATZ specifications are mandatory for engine operation which meets exhaust emission regulations:

- High Pressure Unit-Pump
- Injection nozzle(s)
- Intake and exhaust manifold
- Crankcase breather valve assembly
- Oil filler cap
- Diesel Oxidation Catalyst
- Electronic control unit
- Oil temperature sensor
- Engine speed sensor
- Wiring harnesses
- Fuel hoses
- Intake and exhaust gaskets
- Emission Control Information Labels

Only parts manufactured by Hatz and which have passed the Hatz Quality Assurance Program have been assured of meeting EPA and CARB exhaust emission regulations.

HATZ DIESEL SUPPLEMENTAL WARRANTY FOR MODEL YEAR 2024 EPA AND / OR CARB CERTIFIED ENGINES.

PARTS WITH SUPPLEMENTAL LIMITED WARRANTY.

The following limited warranty is supplemental to the standard HATZ DIESEL LIMITED ENGINE WARRANTY and covers Model Year 2024 EPA and / or CARB certified engines and applies to the exhaust emission-related components are also listed in this manual.

SUPPLEMENTAL LIMITED WARRANTY.

Hatz Diesel of America, Inc. hereinafter referred to as "HATZ" warrants each of the above-listed parts when installed in a new engine sold by Hatz to be free from defects in material and workmanship under normal use and service, only under the named warranty coverage conditions, after the date of delivery to the original retail purchaser and Hatz will at their option, repair or replace at Hatz's sales headquarters, or at a point designated by Hatz, any part or parts which shall appear to the satisfaction of Hatz upon inspection at such point, to have been defective in material or workmanship.

- Any warranted part which is scheduled for replacement as required maintenance is warranted for the period of time up to the first scheduled replacement point for that part.
- Any replacement part which is equivalent in performance and durability may be used in non-warranty maintenance or repairs and will not reduce the overall engine warranty obligations of Hatz. However, Hatz is not responsible for failure of such replacement parts or failure of any other parts directly caused by failure of such replacement parts.
- This warranty does not obligate Hatz to bear any transportation charges in connection with the repair or replacement of defective parts. This warranty is transferrable to subsequent owners, only under the named warranty coverage conditions.
- In order to obtain service under this warranty, the retail purchaser should contact Hatz Diesel of America, Inc. at (262)-544-0254 for information and the nearest service center. The retail purchaser will not be charged for diagnostic labor which leads to the determination that a warranted part is defective, nor for the repair or replacement of warranted parts if the work is performed at an authorized Hatz service center. If other engine components are damaged due to a failure of the above-listed warranted parts still under warranty, these other engine components will also be repaired or replaced at no charge.
- This warranty shall not apply to any engine which shall have been installed or operated in a manner not recommended by Hatz, nor to any engine which shall have been repaired, altered, neglected, or used in any way which, in the opinion of Hatz, adversely affects its performance, nor to any engine in which parts not authorized by Hatz have been used, which parts or the use of which have damaged or caused defects in or otherwise adversely affected the engine or its performance, nor to normal maintenance service or replacement of normal service items.

Hatz reserves the right to modify, alter, and improve any engine or parts in accordance with the applicable regulations without incurring any obligation to replace any engine or parts previously sold with such modified, altered, or improved engine or parts.

EMISSION-RELATED INSTALLATION INSTRUCTIONS.

“Failing to follow the Emission related installation instructions provided by Motorfabrik Hatz when installing a certified engine in a piece of nonroad equipment violates federal law (40CFR1068.105(b)), subject to fines or other penalties as described in the Clean Air Act.”

The emission related installation instructions can be downloaded at <http://www.hatz-diesel.com/doku/assembly-instructions.html>

“If you install the engine in a way that makes the engine's emission control information labels hard to read during normal engine maintenance, you must place duplicate labels on the equipment.”

Assembly and handling of emission related components (e.g. catalyst mounting on the non-road equipment) are explained in the manual.

13 EPA CERTIFIED ENGINES WITHIN CALIFORNIA**SUPPLEMENTAL INFORMATION
TO THE OWNER'S MANUAL
FOR THE USE OF EPA CERTIFIED ENGINES
WITHIN CALIFORNIA.**

The following information is taken from the official CARB website.

"The 1990 amendments to the federal Clean Air Act preempt California control of emissions from new farm and construction equipment under 175 horsepower. Emissions from these new engines are beyond ARB's authority to regulate. The U.S. EPA has sole authority to establish emission standards for these preempt engines used in new farm and construction equipment under 175 horsepower. However, these equipment types may become subject to ARB's In-Use Off-Road Vehicle Regulations which target diesel particulate matter (PM) and oxides of nitrogen (NOx) emissions from in-use (existing) off-road heavy-duty diesel vehicles, and hydrocarbons (HC) and NOx emissions from in-use large spark-ignition (LSI) engine forklifts and other industrial equipment. For more information, please refer to ARB's In-Use Off-Road Vehicle Regulations web page for in-use off-road diesel vehicles (<http://www.arb.ca.gov/msprog/ordiesel/ordiesel.htm>) requirements."

For the latest information please see
<https://ww2.arb.ca.gov/sore-list-determine-preempt-road-applications>



Please also see information regarding the federal non-road engine emissions control program (<http://www.epa.gov/nonroad/>)





WARNING: Breathing diesel engine exhaust exposes you to chemicals known to the State of California to cause cancer and birth defects or other reproductive harm.

- Always start and operate the engine in a well-ventilated area.
- If in an enclosed area, vent the exhaust to the outside.
- Do not modify or tamper with the exhaust system.
- Do not idle the engine except as necessary.

For more information go to www.P65warnings.ca.gov/diesel

0413 550 00

Motorenfabrik Hatz GmbH & Co. KG

Ernst-Hatz-Str. 16

94099 Ruhstorf a. d. Rott

Deutschland

Tel. +49 8531 319-0

Fax. +49 8531 319-418

marketing@hatz-diesel.de

www.hatz-diesel.com



CREATING POWER SOLUTIONS.

0000 436 015 04 - 06.2023

Printed in Germany

USA-EPA IV - CARB