

CREATING POWER SOLUTIONS.

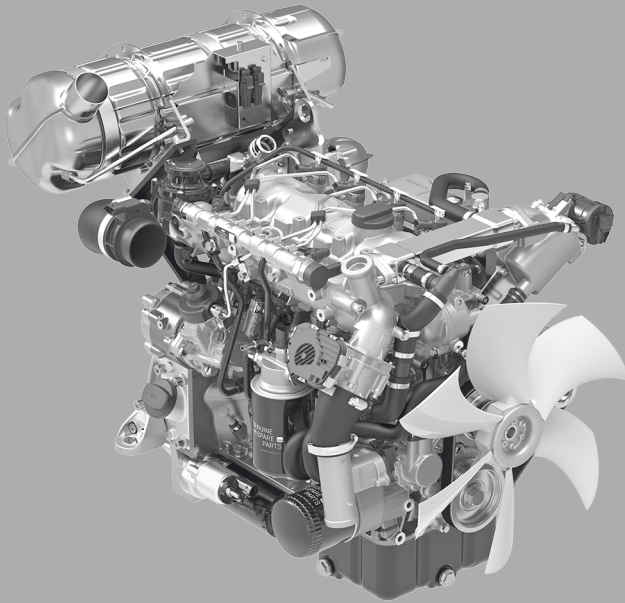

---

3H50 | 4H50

---

**MANUAL**  
for diesel engine

**Hatz Diesel**

[www.hatz-diesel.com](http://www.hatz-diesel.com)



<b>1</b>	<b>Legal notices</b> .....	<b>5</b>
<b>2</b>	<b>General information</b> .....	<b>6</b>
<b>3</b>	<b>Safety</b> .....	<b>7</b>
3.1	General information.....	7
3.1.1	Intended use .....	7
3.1.2	Machine user or machine manufacturer obligations .....	8
3.1.3	Representation of safety notes .....	9
3.1.4	Meaning of safety symbols.....	10
3.2	Safety notes .....	12
3.2.1	Operational safety .....	12
3.2.2	Machine-specific safety instructions for operation .....	15
3.2.3	Machine-specific safety instructions for maintenance work .....	16
3.2.4	Electrical equipment.....	18
3.3	Labels.....	19
<b>4</b>	<b>Technical data</b> .....	<b>21</b>
4.1	Engine information and filling quantities .....	21
4.2	Engine type plate .....	25
4.2.1	Engine serial number .....	26
4.3	Engine oil .....	27
4.4	Coolant.....	28
4.5	Fuel .....	32
<b>5</b>	<b>Engine overview</b> .....	<b>34</b>
5.1	Designation of components.....	34
5.2	Fuses .....	44
5.3	Hatz Smart Panel (HSP) .....	45
5.3.1	Main menu .....	45
5.3.2	Menu – Current Values .....	49
5.3.3	Menu – General Settings .....	51
<b>6</b>	<b>Transport, installation and commissioning</b> .....	<b>53</b>
6.1	Transport.....	53
6.2	Installation notes .....	56
6.3	Preparations for commissioning.....	57
6.4	Filling engine oil (first filling).....	58
6.5	Filling the cooling system .....	59
6.6	Venting the fuel system.....	61
<b>7</b>	<b>Operation and use</b> .....	<b>63</b>
7.1	Safety notes .....	63
7.2	Performing tests .....	64
7.3	Starting the engine .....	65
7.4	Switching off the engine .....	68

7.5	Check the oil level .....	70
7.6	Refueling .....	72
7.7	Regenerating the diesel particulate filter .....	73
<b>8</b>	<b>Maintenance .....</b>	<b>79</b>
8.1	General maintenance instructions .....	79
8.2	Maintenance work .....	80
8.2.1	Maintenance plan .....	80
8.2.2	Additional work on the Silent Pack .....	84
8.2.3	Check the intake area of the combustion air .....	87
8.2.4	Check the cooler fins for contamination .....	89
8.2.5	Check the cooling system .....	90
8.2.6	Changing the engine oil and oil filter .....	93
8.2.7	Clean the radiator fins .....	99
8.2.8	Checking the poly v belt .....	102
8.2.9	Replacing the poly v belts .....	106
8.2.10	Change the oil separator of the crankcase ventilation .....	111
8.2.11	Check the screw connections .....	112
8.2.12	Drain the water separator .....	112
8.2.13	Changing the fuel prefilter .....	114
8.2.14	Changing the main fuel filter .....	116
8.2.15	Servicing the air filter (optional) .....	119
8.2.16	Change the coolant .....	121
8.2.17	Draining the charge air cooler .....	124
8.2.18	Resetting the service interval indicator .....	125
<b>9</b>	<b>Faults .....</b>	<b>128</b>
9.1	Troubleshooting .....	128
9.2	Diagnostic trouble codes in case of engine malfunctions .....	131
9.3	Start support .....	132
<b>10</b>	<b>Storage and disposal .....</b>	<b>137</b>
10.1	Storing the machine .....	137
10.2	Disposing of the machine .....	139
<b>11</b>	<b>Declaration of incorporation .....</b>	<b>140</b>
<b>12</b>	<b>Declaration of the manufacturer .....</b>	<b>141</b>



# 1 Legal notices

## Contact data

© 2023  
 Motorenfabrik Hatz  
 Ernst-Hatz-Straße 16  
 94099 Ruhstorf  
 Germany  
 Tel. +49 (0)8531 319-0  
 Fax +49 (0)8531 319-418  
 marketing@hatz-diesel.de  
 www.hatz-diesel.com  
 All rights reserved!

## Copyright

The copyright for this manual rests entirely with Motorenfabrik HATZ, Ruhstorf.

This manual may only be copied or distributed if written approval has been received. This also applies to the copying or distribution of excerpts of this manual. The same conditions apply to distribution of this manual to third parties in digital form.

## Original manual

This manual has been translated into multiple languages.

The German version is the **original manual**. All other language versions are **translations** of the **original manual**.

## Revision

Version	Date	Name
06 - Rev. 00	06.06.2023	GMV / ef
07 - Rev. 00	08.12.2023	GMV / ef

## 2 General information

### Information on the document

This manual was created with due care. It is exclusively intended to offer a technical description of the machine and to provide instructions on commissioning, operating and maintaining the machine. When operating the machine, the applicable standards and legal regulations as well as any in-house regulations apply.

Before commissioning, during operation and before maintenance work is begun on the machine, read this manual carefully and keep it close by for ready access.

### Machine

This manual describes the following machine.

Machine name	HATZ diesel engine
Type number	3H50T, 3H50TI, 3H50TIC, 3H50TICD, 4H50TI, 4H50TIC, 4H50TICD

### Customer service

Have service work performed by qualified technicians only. We recommend that you work with one of the over 500 **HATZ service stations**. Trained specialists there will repair your machine with **Hatz original spare parts** and with **HATZ tools**. The global HATZ service network is at your disposal to advise you and supply you with spare parts. For the address of the **Hatz service station** nearest you, please see the enclosed spare parts list or visit us in the Internet at: [www.hatz-diesel.com](http://www.hatz-diesel.com)

Installation of unsuitable spare parts can lead to problems. We cannot accept liability for direct damage or secondary damage that results from this.

We therefore recommend the use of **Hatz original spare parts**. These parts are manufactured according to strict Hatz specifications and achieve maximum operational reliability through their perfect fit and functionality. The order number can be found in the enclosed spare parts list or on the Internet at: [www.hatz-diesel.com](http://www.hatz-diesel.com)

### Exclusion of liability

The manufacturer cannot be held liable for personal injury, damage to property or damage to the machine itself caused by improper use, foreseeable misuse, or failure to follow or adequately follow the safety measures and procedures described in this manual. This also applies to changes made to the machine and the use of unsuitable spare parts.

Modifications, which serve the technical improvements, are reserved.

## 3 Safety

### 3.1 General information

#### Introduction

This chapter contains the information you need to work safely with this machine.

To prevent accidents and damage to the machine, it is imperative that these safety instructions be followed.

Read this chapter carefully before beginning work.

#### 3.1.1 Intended use

##### Intended use

The machine described in this manual fulfills the following functions:

- Diesel engine intended for installation in a machine or for assembly with other machines to form a machine. See chapter *11 Declaration of incorporation, page 140*.

This engine is intended exclusively for the purpose specified and tested by the manufacturer of the machine in which the engine is installed.

Any other use is not intended and therefore not permitted. Violations compromise the safety of the personnel working with the machine. Motorenfabrik HATZ does not accept any liability for damage resulting from this.

The operational safety of the machine is only guaranteed if it is used as intended.

Use according to the intended purpose also includes observance of the instructions in this Operator's Manual

##### Foreseeable misuse

The following is considered to be foreseeable misuse:

- Any use that varies from or extends beyond the uses specified above.
- Failure to comply with the instructions given in this manual.
- Failure to comply with the safety instructions.
- Failure to immediately eliminate malfunctions that impact safety before continuing work with the machine (working with the machine when it is not in perfect condition, either functionally or in terms of safety).
- Failure to perform the necessary inspection and maintenance work.
- Any unauthorized modification of or removal of safety equipment.
- Use of spare parts and accessories that are unsuitable or have not been approved by HATZ.
- Fuel other than specified in the instructions.
- Operation in flammable or hazardous environments.

- Operation in closed-off or poorly ventilated rooms.
- Operation in an aggressive atmosphere (e.g., high salt content) without further measures for corrosion protection.
- Improper operation at variance with DIN ISO 3046 -1 and DIN ISO 8528 (climate, load, safety).

### Residual risks

Residual risks result during daily use and in association with maintenance work.

These residual risks will be pointed out in chapter 3.2.2 *Machine-specific safety instructions for operation, page 15* and in chapter 3.2.3 *Machine-specific safety instructions for maintenance work, page 16* as well as in the further contents of the manual, directly in front of the descriptions or operating instructions concerned.

## 3.1.2 Machine user or machine manufacturer obligations

### Machine manufacturer obligations

If you have an engine that is not yet installed in a machine, it is imperative that you follow the **Assembly Instructions for HATZ Diesel Engines** before installing the engine. These assembly instructions contain important information on how to safely install the engine and are available at your nearest **HATZ service station**.

**It is prohibited to start the engine before it is fully installed.**

In addition, please note that it is prohibited to start up the machine before it has been determined that the machine into which this engine is installed fulfills all safety-related requirements and legal regulations.

### User obligations

The operator is obliged to only operate the machine when it is in perfect condition. The operator must check the condition of the machine before use and ensure that any defects are eliminated before it is taken into service. Running the machine while identified defects exist is not permitted. The operator must also ensure that all persons who work on the machine are familiar with the contents of this manual.

### Obligations of the operating and maintenance personnel

Personnel assigned with operating and maintaining the machine must have read and understood this manual or must possess the qualifications necessary for working with this equipment, acquired in training/instructional courses. No one may work with the machine without the necessary qualifications, even if for just a brief period.

The operating and maintenance personnel must not be under the influence of drugs, medication or alcohol.

All work performed on the machine must be in compliance with the information provided in this manual.

### **Storing this manual**

This manual is an integral component of the machine (also when being sold). It must be stored in the direct vicinity of the machine and be accessible to personnel at all times.

### **3.1.3 Representation of safety notes**

#### **Overview**

This machine has been designed and built according to state-of-the-art technology and the recognized safety standards. Despite these precautions, risks exist when operating the machine and during maintenance work.

These risks are identified in this manual by means of safety notes.

The safety notes precede the relevant description or operating step.

#### **Structure of the safety notes**

The safety notes consist of:

- Danger symbol
- Signal word
- Description of the danger
- Possible consequences
- Preventative measures



#### **General danger symbol**



The general danger symbol is used to identify the danger of personal injury.

## Signal words





Signal words identify the magnitude of the risk and the seriousness of possible injury:

Danger symbol/ signal word	Meaning
 <b>DANGER</b>	This signal word is used to indicate imminently dangerous situations which, if not avoided, will lead to serious injury or death.
 <b>WARNING</b>	This signal word is used to indicate potentially dangerous situations which, if not avoided, may lead to serious injury or death.
 <b>CAUTION</b>	This signal word is used to indicate potentially dangerous situations which, if not avoided, may lead to minor or moderate injury.
<b>CAUTION</b>	This signal word, without a danger symbol, is used to indicate the risk of property damage.
<b>NOTICE</b>	This signal word indicates additional useful information, such as operating tips and cross references.

### 3.1.4 Meaning of safety symbols

#### Explanation of symbols

The following table describes the meanings of the safety symbols used in this manual.

Symbol	Meaning
	Smoking, fire, and open flames are prohibited!
	Warning of personal injury!
	Warning of hot surfaces!
	Warning of hot surfaces! (Alternative)



Symbol	Meaning
	Warning of flammable substances!
	Warning of explosive substances!
	Warning of toxic engine exhaust!
	Warning of corrosive substances!
	Warning of heavy loads!
	Warning of environmental damage!
	Comply with this manual or additional documentation from other manufacturers or the operator.
	Additional information that is useful to the reader.

## 3.2 Safety notes

### 3.2.1 Operational safety

#### Introduction

This chapter contains all of the important safety instructions for personal protection and for safe and reliable operation. Additional, task-related safety instructions can be found at the beginning of each chapter.

 <b>DANGER</b>	
	<p><b>Danger to life, danger of injury or danger of property damage due to failure to comply with this manual and the safety instructions contained therein.</b></p> <ul style="list-style-type: none"> <li>▪ As the operator of the machine, you must ensure that all people working on the machine are familiar with the content of this manual.</li> <li>▪ Before working on the machine, read this manual carefully, paying special attention to the safety notes</li> <li>▪ Fulfill all required safety conditions before working on the machine.</li> <li>▪ Follow all general safety instructions as well as the specific task-related safety instructions contained in the individual chapters.</li> </ul>

#### Using the machine

- Only operate the machine for the purposes described in chapter 3.1.1 *Intended use*, page 7.







#### Compliance with other regulations

- The applicable regulations of the relevant professional associations must be observed.
- Comply with the regulations concerning the minimum safety and health requirements for the use of work equipment by workers at work.
- In addition, local safety, accident prevention and environmental regulations also apply when operating the machine.

#### Personal protective equipment

During operation and maintenance of the machine, personal protective equipment must be available and must be used if necessary. The use of personal protective equipment is specified in the description of the operating steps.



Personal protective equipment	Pictogram	Function
Safety shoes		Safety shoes offer protection against: <ul style="list-style-type: none"> <li>▪ Slipping</li> <li>▪ Falling objects</li> </ul>
Hearing protection		Hearing protection offers protection against ear injuries due to excessive and constant noise.
Safety gloves		Safety gloves protect the hands against injury, e.g., from battery acid.
Safety goggles (with side protection)		Safety goggles protect the eyes from flying objects (e.g., dust particles, spraying liquids, spraying acid).
Fine dust mask		A fine dust mask protects the wearer against particulate pollutants.
Working clothes		Wear close-fitting working clothes. It must not restrict the wearer's freedom of movement, however.

### Warning labels and information signs on the machine

The warning labels and information signs on the machine must be followed (see chapter "Labels" 3.3 *Labels*, page 19).

The warning labels and information signs must be kept legible and must be replaced if necessary. For this purpose, contact your nearest **HATZ service station**.

### Maintenance work









Maintenance work that goes beyond the scope described in this manual must only be performed by qualified technicians (see chapter 2 *General information*, page 6).

Independent maintenance work and constructional changes to the machine, especially to the safety equipment, are not permitted.

## Safety equipment

Safety equipment must not be modified and must not be rendered ineffective during normal operation.

## General safety instructions

 <b>DANGER</b>	
	<p><b>Danger to life and danger of injury due to failure to follow the warnings on the machine and in this manual.</b></p> <ul style="list-style-type: none"> <li>▪ Heed the warnings on the machine and in this manual.</li> </ul>
 <b>WARNING</b>	
	<p><b>Danger of injury and danger of incorrect operation due to inadequate personnel qualifications.</b></p> <ul style="list-style-type: none"> <li>▪ The personnel must have read and understood this manual or must possess the qualifications necessary for working with this equipment, acquired in training/instructional courses.</li> <li>▪ Only qualified personnel is permitted to operate and maintain this machine.</li> <li>▪ Failure to comply will cause the warranty to become void.</li> </ul>
 <b>WARNING</b>	
	<p><b>Danger of injury from failure to follow the Operating Instructions and from performing unauthorized tasks on the machine.</b></p> <ul style="list-style-type: none"> <li>▪ Follow all instructions.</li> <li>▪ Do not perform activities for which no qualification is available. Contact properly trained personnel if necessary.</li> </ul>
 <b>CAUTION</b>	
	<p><b>Danger of injury from overloading the body.</b></p> <p>Lifting the machine to transport it or to move it to another location can lead to injuries (of the back, for example).</p> <ul style="list-style-type: none"> <li>▪ Only lift the machine with a hoist (see chapter 6.1 <i>Transport</i>, page 53).</li> </ul>

## 3.2.2 Machine-specific safety instructions for operation

### Introduction

The machine can pose residual risks during operation. To eliminate these risks, all persons working on the machine must follow the general and machine-specific safety instructions.

If you have an engine that is not yet installed in a machine, it is imperative that you follow the **Assembly Instructions for HATZ Diesel Engines** before installing the engine.

These Assembly Instructions contain important information on safe installation.

If the engine is installed in a machine or assembled with other machines to form a machine, it is prohibited to start the engine before it has been determined that the newly created machine fulfills all safety-related requirements and applicable legal regulations.



### Safe operation





- Before switching on the machine, ensure that no one can be injured when the machine is started up.
- During machine operation, ensure that unauthorized persons do not have access to the area in which the machine has an impact.
- Parts of the exhaust gas system and the surface of the engine become hot during operation. Risk of injury from touching hot parts! Let the engine cool before maintenance.
- Do not refuel during operation.

### Faults

- Immediately eliminate faults that compromise safety.
- Switch off the machine and do not take into service again until all faults have been eliminated.

### Safety instructions for operation

 <b>DANGER</b>	
	<p><b>Danger to life from inhaling exhaust gases.</b></p> <p>Toxic engine exhaust gases can lead to loss of consciousness, and even death, in closed-off and poorly ventilated rooms.</p> <ul style="list-style-type: none"> <li>▪ Never operate the machine in closed-off or poorly ventilated rooms.</li> <li>▪ Do not breathe in the exhaust gases.</li> </ul>

 <b>DANGER</b>	
	<p><b>Fire hazard from fuel.</b></p> <p>Leaked or spilled fuel can ignite on hot engine parts and cause serious burn injuries.</p> <ul style="list-style-type: none"> <li>▪ Only refuel when the engine is switched off and has cooled down.</li> <li>▪ Never refuel in the vicinity of open flames or sparks that can cause ignition.</li> <li>▪ Do not smoke.</li> <li>▪ Do not spill fuel.</li> </ul>
 <b>DANGER</b>	
	<p><b>Danger of fire from hot exhaust gas system.</b></p> <p>If inflammable materials come into contact with the exhaust gas flow or the hot exhaust gas system, these materials can ignite.</p> <ul style="list-style-type: none"> <li>▪ Keep inflammable materials away from the exhaust gas system.</li> <li>▪ Do not operate the engine (exhaust flow or hot exhaust gas system) in the direct vicinity of combustible materials.</li> </ul>

### 3.2.3 Machine-specific safety instructions for maintenance work

#### Introduction

The machine can pose residual risks during maintenance. To eliminate these risks, all persons working on the machine must follow the general and machine-specific safety instructions.

#### Maintenance intervals

- Strictly adhere to the maintenance intervals.
- Check the safety equipment regularly to ensure it is in good condition and functioning properly.
- Check connections, cables and fasteners regularly to ensure they are in good condition.

#### Maintenance work

Maintenance work that goes beyond the scope described in this manual must only be performed by qualified technicians. We recommend that you work with one of the over 500 **HATZ service stations**.







### Replacing parts



- When replacing defective components, we recommend that you use **Hatz original spare parts** (see chapter 2 *General information, page 6*).
- When disposing of parts that can no longer be used, do so in accordance with local environmental regulations or send them to a recycling center.

### Measures following maintenance and troubleshooting

- Securely reconnect loose electrical connections; check that the electrical components and equipment are functioning properly.
- Check the entire machine for foreign bodies; remove any foreign bodies.



### Safety instructions for maintenance work



 <b>DANGER</b>	
	<p><b>Danger of explosion from flammable cleaning agents.</b></p> <p>Cleaning with benzene is an explosion hazard. It is highly flammable, can become electrostatically charged, and can generate an explosive gas/air mixture.</p> <ul style="list-style-type: none"> <li>▪ Use halogen-free, cold cleaners with a high flash point for cleaning.</li> <li>▪ Comply with manufacturer's instructions.</li> </ul>
 <b>WARNING</b>	
 	<p><b>Danger of injury from compressed air and dust particles.</b></p> <p>Eye injuries can occur when cleaning with compressed air.</p> <ul style="list-style-type: none"> <li>▪ Wear safety goggles.</li> </ul>
 <b>CAUTION</b>	
	<p><b>Danger of injury from ignoring the maintenance instructions.</b></p> <ul style="list-style-type: none"> <li>▪ Only perform maintenance work when the engine is switched off.</li> <li>▪ For engines with an electric starter: Disconnect the negative battery terminal. Protect the starting key from unauthorized access.</li> </ul>



 <b>CAUTION</b>	
	<p><b>Danger of burns.</b></p> <p>There is a danger of burns when working on a hot engine.</p> <ul style="list-style-type: none"> <li>▪ Let the engine cool before maintenance.</li> </ul>

### 3.2.4 Electrical equipment

#### Safety notes

 <b>DANGER</b>	
	<p><b>Danger to life, danger of injury or danger of property damage due to incorrect use of batteries.</b></p> <ul style="list-style-type: none"> <li>▪ Do not place tools or other metal objects on the battery.</li> <li>▪ Before performing work on the electrical equipment, always disconnect the negative battery terminal.</li> <li>▪ Never swap the plus (+) and negative (–) battery terminals.</li> <li>▪ When installing the battery, first connect the <b>plus cable</b> and then the <b>negative cable</b>.</li> <li>▪ When removing the battery, first disconnect the <b>negative cable</b> and then the <b>plus cable</b>.</li> <li>▪ It is imperative to prevent short circuits and mass contact of current carrying cables.</li> <li>▪ If faults occur, check the cable connections for good contact.</li> </ul>

 <b>DANGER</b>	
	<p><b>Danger of explosion from flammable substances.</b></p> <p>There is a danger of explosion from flammable gases.</p> <ul style="list-style-type: none"> <li>▪ Keep batteries away from open flames and incendiary sparks.</li> <li>▪ Do not smoke when working with batteries.</li> </ul>

 <b>CAUTION</b>	
	<p><b>Danger of chemical burns</b></p> <p>Chemical burns can occur when using batteries for the electrical operation.</p> <ul style="list-style-type: none"> <li>▪ Protect your eyes, skin, and clothing from corrosive battery acid.</li> <li>▪ Immediately rinse areas affected by splashed acid with clear water and consult a physician if necessary.</li> </ul>



- Promptly replace defective indicator lamps.
- Do not disconnect the battery while the machine is running. Resulting voltage peaks could destroy the electronic components.
- When performing welding work on the machine, disconnect the battery and place the ground clamp of the welding equipment as close as possible to the welding area. Disconnect the plug connectors to the engine control unit and to the voltage regulator of the three phase alternator.

<b>NOTICE</b>	
	<ul style="list-style-type: none"> <li>▪ We cannot be held liable for electrical equipment that is not designed according to HATZ wiring diagrams.</li> </ul>

### 3.3 Labels

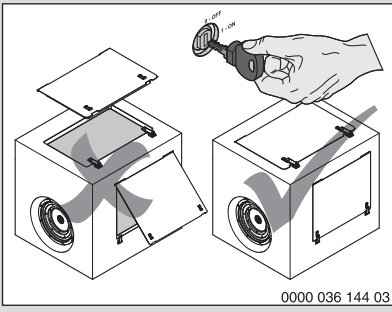
#### Warning labels and information signs on the engine

sign	Meaning
<p>Engine specification <b>Silent Pack</b></p> 	<p><b>CAUTION!</b> Danger of injury from rotating parts.</p> <ul style="list-style-type: none"> <li>▪ Only operate the engine when all covers are installed.</li> </ul>

sign	Meaning
 <p style="text-align: center;">or</p> 	<p>Warning of hot surfaces!</p>
	<p>Cleaning with a high pressure cleaner is prohibited!</p> <ul style="list-style-type: none"> <li>▪ Do not spray the Hatz instrument box with a high-pressure water jet.</li> </ul>

**Warning labels and information signs on the battery (option)**

sign	Meaning
 <p style="text-align: center;">Pb</p>	<ol style="list-style-type: none"> <li>1. Fire, sparks, open flames and smoking are prohibited: avoid causing sparks when working with cables and electrical machines. Avoid short-circuits.</li> <li>2. Follow the instructions on the battery and in the battery user manual.</li> <li>3. Keep children away from acid and batteries.</li> <li>4. Danger of explosion: A highly explosive electrolytic gas is created when batteries are charged.</li> <li>5. Wear safety goggles when filling.</li> <li>6. Danger of chemical burns: Battery acid is highly corrosive. Therefore, wear safety gloves and eye protection. Do not tilt the battery; acid may spill out of the vent openings.</li> <li>7. Do not dispose of the battery with the household trash.</li> <li>8. Take the used battery to a collection center.</li> </ol>



## 4 Technical data

### 4.1 Engine information and filling quantities

Type		3H50	4H50
Type		Liquid-cooled four stroke diesel engine	
Combustion system		Direct injection	
Number of cylinders		3	4
Bore/Stroke	mm	84 / 88	84 / 88
Displacement	Liter	1.463	1.951
Engine oil consumption (after running-in period)	Max.	0.5 % of fuel consumption, pertaining to full load	
Engine oil pressure		2.5 bar to 4.5 bar	
Sense of rotation		Left (view toward flywheel)	
Tappet clearance		Automatic hydraulic valve adjustment (maintenance-free)	
Max. perm. continuous tilt position <sup>1)</sup>		HATZ cooler with <b>integrated expansion tank</b> cooler low: 20°, other parts: 30°	
		HATZ cooler with <b>external expansion tank</b>	
		30°	30°
		40° <sup>2)</sup>	35° <sup>2)</sup>
Battery capacity	Max.	12 V – 110 Ah / 760 A (EN) / 800 A (SAE)	
		24 V – 66 Ah / 510 A (EN) / 540 A (SAE)	

<sup>1)</sup> Exceeding these limit values causes engine damage!

<sup>2)</sup> Permissible tilt position for a maximum of 7 hours. After this period, return the engine from the tilt position to the horizontal position and switch it off for at least 5 minutes. Merely a reduction in the tilt position is not sufficient.

## Engine specifications

Model	Description
T	With turbocharger.
TI	with turbocharger and charge air cooling.
TIC	With turbocharger, charge air cooling, cooled exhaust gas recirculation (EGR) and diesel oxidation catalyst (DOC)
TICD	With turbocharger, charge air cooling, cooled exhaust gas recirculation (EGR), diesel oxidation catalyst (DOC) and diesel particulate filter (DPF).
OPU	Open Power Unit. Complete system with all components required for engine cooling.
Silent Pack	Open Power Unit with noise and weather protection capsule.

## Engine oil capacities

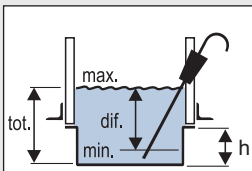
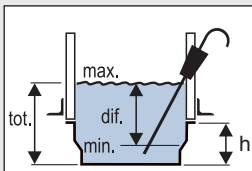
	Oil sump *					
						
Type	h (mm)	tot. ltr. <sup>1)</sup>	dif. ltr. <sup>2)</sup>	h (mm)	tot. ltr. <sup>1)</sup>	dif. ltr. <sup>2)</sup>
<b>3H50</b>	118	5.0	0.8	149	5.9	1.0
<b>4H50</b>	118	7.0	1.0	149	7.3	1.0
	148	9.0	1.0			

\* To determine the engine oil capacity, note dimension (h) and the oil sump contour.

<sup>1)</sup> **tot. ltr.:** Engine oil capacity (in liters) for oil change with filter change.

<sup>2)</sup> **dif. ltr.:** Oil refill quantity (in liters) between the "min" and "max" marking on the dipstick.

These values are approximations only. The max. mark on the dipstick is decisive in any case (see chapter 7.5 *Check the oil level*, page 70).

**Coolant filling quantities (engines with Hatz cooler)**

	Hatz cooler	
	With external expansion tank	With integrated expansion tank
Type	Filling quantity in liters *	
3H50 T	–	7.9
3H50 TI	12,6	13.3
3H50 TIC	12,6	13.3
3H50 TICD	12,6	13.3
4H50 Ti	13.7	14,4
4H50 TIC	13.7	14,4
4H50 TICD	13.7	14,4

\* These values are approximations only. The **MAX** marking on the dipstick applies in all cases (see section 6.5 *Filling the cooling system*, page 59).

**Weights (without operating fluids)**

	Model		
	Standard	OPU	Silent Pack
Type	Weight in kg		
3H50 T	132 *	188	–
3H50 TI	133 *	215	312
3H50 TIC	154 *	236	333
3H50 TICD	161 *	243	345
4H50 Ti	152 *	234	333
4H50 TIC	173 *	255	354
4H50 TICD	180 *	262	366

\* Without cooler.

**Screw tightening torque**

<b>Designation</b>	<b>Nm</b>
Oil drain screw	58
Drain screw on engine cooler	50
Drain screw on charge air cooler	50
Connection and fixing screws ( <b>M10</b> ) for protective guard (engine specification <b>TI, TIC, TICD</b> )	30
Connection and fixing screws ( <b>M8</b> ) for protective guard (engine specification <b>T</b> )	23
Screws for the breather cap of the crankcase ventilation	4

## 4.2 Engine type plate

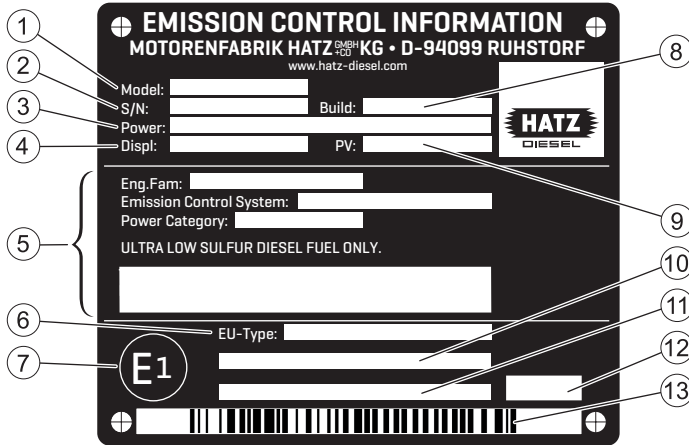

The engine type plate is affixed to the crankcase and includes the following engine information:

1	Model designation of the engine
2	Engine serial number
3	Engine power (kW) at rated speed (rpm)
4	Displacement (liters)
5	Information for US emission certification (EPA/CARB)
6	EU type approval number
7	EU country of origin (Germany)
8	Model year (month/year)
9	Test specification for special settings
10	Engine family designation or exemption code (EM) or transition code (TM) according to regulation (EU) 2016/1628
11	Additional specifications according to Regulation 2017/656 (exceptions) or "Separate shipment information"
12	Code for type plate variant
13	Barcode (engine serial number)

The following data must always be specified in case of queries and for spare parts orders:

1	Model designation
2	Engine serial number

## 4.2.1 Engine serial number

### Breakdown of the engine serial number

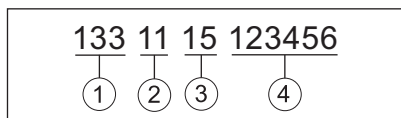

1	Engine type number
2	Engine serial number
3	Model year
4	Fabrication number (consecutive)

### Engine type number

The engine type number makes it possible to see if the engine is equipped with a diesel oxidation catalyst (DOC). There are more stringent requirements on engine oil and fuel quality for engines with DOC (see chapter 4.3 *Engine oil*, page 27 and chapter 4.5 *Fuel*, page 32). The following table shows which engine types are equipped with DOC.

Engine type number	Type number	DOC
135	3H50TIC	X
136	4H50TIC	X
161	4H50TI	
163	3H50TI	
164	3H50TICD	X
165	4H50TICD	X
178	3H50T	

## 4.3 Engine oil

### Oil quality

All oil brands that meet at least one of the following specifications are suitable:

#### Engines with diesel oxidation catalyst (DOC)

(for details, see section 4.2.1 *Engine serial number, page 26*).

- **ACEA E6 or E8** (recommended)
- **ACEA E9 or E11**
- **ACEA C3 / C4** (HTHS  $\geq 3.5$  mPas)
- **API CK-4 or CJ-4**

### CAUTION

#### Damage to the diesel oxidation catalyst (DOC) from using unsuitable engine oil.

Unsuitable engine oil diminishes the functionality and service life of the catalytic converter and diesel particulate filter.

Only use engine oils with very low quantities of sulfate ash, phosphor and sulfur – so-called "low SAPS" oils which fulfill at least one of the specifications mentioned above.

#### Engines without diesel oxidation catalyst (DOC)

(for details, see section 4.2.1 *Engine serial number, page 26*).

- **ACEA E6, E7 or E9**
- **ACEA C1, C2, C3 or C4**
- **API CK-4, CJ-4 or CI-4**

### Oil viscosity

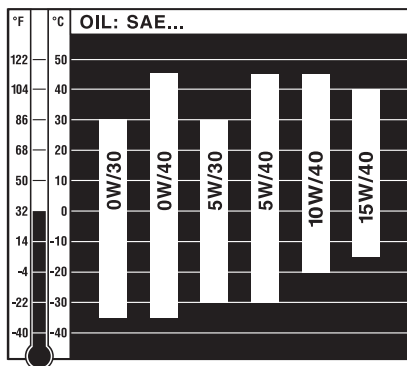

Select the recommended viscosity depending on the ambient temperature at which the engine will be operated.

<b>CAUTION</b>	
	<p><b>Engine damage from unsuitable engine oil.</b></p> <p>Unsuitable engine oil considerably reduces engine service life. Only use engine oil that fulfills the specifications stipulated above.</p>

## 4.4 Coolant



### Introduction



Liquid-cooled engines require a coolant specified by HATZ for engine cooling.

Coolant is prepared in accordance with manufacturer's instructions, please comply with the information on the packaging label.

Cooler protection fluids give effective protection against corrosion and freezing. In addition, the coolant boiling point is significantly raised and deposits of lime in the cooling system are reduced.

### Safety notes

 <b>CAUTION</b>	
	<p><b>Danger of damage to health</b></p> <p>Cooler protection fluids are harmful to health.</p> <ul style="list-style-type: none"> <li>▪ Avoid contact to eyes and skin.</li> <li>▪ Store only in the sealed original container and in a place inaccessible for unauthorized persons.</li> <li>▪ Comply with manufacturer's instructions.</li> </ul>

 <b>CAUTION</b>	
	<p><b>Danger of environmental damage from spilled coolant.</b></p> <p>Coolant is water-polluting.</p> <ul style="list-style-type: none"> <li>▪ Do not allow them to enter the ground water, water bodies, or sewage system.</li> <li>▪ Collect the coolant and dispose of it according to local environmental regulations.</li> </ul>

<b>CAUTION</b>	
	<p><b>Danger of engine damage from cooler protection fluid.</b></p> <p>Use of a cooler protection fluid not approved by HATZ can cause engine damage.</p> <ul style="list-style-type: none"> <li>▪ If you have any questions, please contact your nearest <b>HATZ Service</b> before commissioning the engine.</li> </ul>



## Recommended cooler coolant

Product name	Container	HATZ order no.
<b>H-series Coolant</b>	5 liters	0000 055 413 00

The **H-series Coolant** concentrate is exactly matched to the requirements of your HATZ diesel engine.

## Alternative cooler protection fluids

If no H-series Coolant is available, other cooler protection fluids are approved by HATZ:

manufacturer	Product name
ADECO	ADECO FRIZANTIN G40
AO Obninskogrsintez	Lukoil antifreeze HD G12 K
Aqua Concept	Coracon® BF 6-35
ARAL	Aral Antifreeze Silikatfrei (silicate-free)
Arteco	Havoline XLC (OF02), Havoline XLC+B
Avia	AVIA ANTIFREEZE NG, AVIA COOLANT APN-S
BASF	Glysantin® G30®, Glysantin® G40®
BayWa AG	TECTROL COOLPROTECT SI-OAT
Belgin Madeni Yaglar Tic	LUBEX ANTIFREEZE G-12 PLUS, LUBEX ANTIFREEZE MG-40
BP	BP Procool
Castrol	Radicool SF, Radicool Si OAT
CCI	LLC L415
CEPSA	XTAR SUPER COOLANT Si-OAT
Chevron	Delo XLC Antifreeze/Coolant - Concentrate
CLASSIC	CLASSIC KOLDA UE G30, CLASSIC KOLDA UE G40
Comma	Comma Xstream G40, Mobil Antifreeze Advanced
Coparts	CAR1 Premium Longlife Kühlerschutz C40
ENI S.p.A.	Eni Antifreeze Spezial 12++
ExxonMobil	Mobil Antifreeze Advanced, Mobil Antifreeze Ultra
Finke Mineralölwerke	AVIATICON Finkofreeze F30, AVIATICON Finkofreeze F40
Fuchs	MAINTAIN FRICOFIN G 12 PLUS, MAINTAIN FRICOFIN LL, MAINTAIN FRICOFIN DP

<b>manufacturer</b>	<b>Product name</b>
Gulf	Gulf Eurocool G-40 Concentrate
Huiles Berliet S.A.	RTO Maxigel Plus
INA MAZIVA Ltd.	INA Antifriz BS Super
JMC	JMC coolant JM12 Plus
Kemetyl	CARIX COOLANT PREMIUM LONGLIFE, GLYCOCOOOL LONGLIFE PREMIUM ANTIF.774 D-F, Shell Premium Antifreez Longlife
Kuttenkeuler	Antifreeze K 12 Plus, Antifreeze ANF KK40, Top G 12 Plus, EVO ST40
LAEMMLE	PANOLIN ANTI-FROST MT-650
LUKOIL	LUKOIL COOLANT SOT
Marchem	Marchem AC58XLCB1-CON,
Minerva Oil	PERMA UNIVERSAL LL -37 °C
Mitan	Alpine C12, Alpine C12+, Alpine C30, Alpine C40
Mofin	MOFIN Kühlerschutz M40 Extra
MOL-LUB	EVOX Premium Concentrate
Moove Lubricants	Comma Xstream G30, Comma Xstream G40
MOTOREX AG	Antigel YORK 718, MOTOREX COOLANT M3.0 Concentrate, MOTOREX COOLANT M4.0 Concentrate, YORK 816 Antigel
Nalco	Nalcool NF40
Neste Markkinointi	Neste Pro Coolant XLC, Neste Pro+ Coolant M
Nils	NILS POLAR S-O
Orlen Oil	PETRYGO PLUS Cooler Coolant
Orvema	Protex® B-40
Pakelo Motor Oil S.r.l.	Pakelo Red Coolant OAT, Pakelo Red Coolant SI-OAT
PANOLIN AG	PANOLIN ANTI-FROST MT-650
Petrol	ANTIFRIZ KONCENTRAT, ANTIFRIZ MAX
Petrol Ofisi	PO EXTENDED LIFE COOLANT
PrixMax	PrixMax MEG95

manufacturer	Product name
Raloy Lubricantes	Antifreeze Raloy G-30, Raloy Anticongelante Concentrate (G40)
Recochem	HD Expert™ Endurance
REPSOL LU-BRICANTES	REPSOL ANTI.REF.ORGANICO MAXIMUM QUALITY, REPSOL GUARD REFRIGERANTE ORGANICO MQ
SCT	AG40 Liquido Refrigerante
Sinopec	SINOPEC Antifreeze B25.5
Shell	Shell Coolant Longlife G12+ Concentrate
SMB	POWER COOLING NG
Tedex	Tedex Antifreeze OT LL
Tirreno Industria	TIRRENO ORGANIC COOL G 300 TIRRENO ORGANIC COOL G 400
Total	Total Glacelf Auto Supra, Glacelf SI-OAT
Valvoline	Valvoline OEM Advanced 30, Valvoline OEM Advanced 40, Zerex G 30, Zerex G 40
	NATO S-759

### Preparation of the coolant

#### CAUTION

##### **Danger of engine damage from incorrect cooler protection fluid concentration.**

A too low cooler protection fluid concentration increases the risk of corrosion and also the risk of the cooling system freezing. A cooler protection fluid proportion of over 50 vol% degrades the cooling action and also the protection against frost is reduced. Therefore, serious engine damage may result from exceeding or dropping below the cooler protection fluid concentration.

- The cooler protection fluid must be prepared according to the manufacturer's instructions before filling into the cooling circuit or some cooler protection fluids are also offered as premixed formulations. Be sure to comply with the information on the packaging label.
- If the cooler protection fluid has to be mixed with water, use only clean water that is not too hard. Drinking water with as low a content of salt, minerals and suspended matter as possible is ideal. Demineralized or distilled water is also ideal.

The following values must not be exceeded:

Water quality	Max.
Water hardness (°dGH)	20
Water hardness (mmol/l)	3.6
Chloride content (ppm)	100
Sulfate content (ppm)	100

The coolant mixture ratio must not be below or exceed the following concentration:

Cooler protection fluid	Water	Frost-resistant to approx. *
min. 40 vol%	60 vol%	-24 °C
max. 50 vol%	50 vol%	-36 °C

\* These details depend on the product in question. Be sure to comply with the packaging label.

## 4.5 Fuel

### Fuel type

All types of diesel fuel that meet the minimum requirements of the following specifications are suitable:

- **Europe: EN 590**
- **Europe: EN 15940**  
This is "paraffinic diesel fuel from synthesis or hydrotreatment", frequently available under the abbreviations XTL (X-to-liquid), BTL (biomass-to-liquid), GTL (gas-to-liquid), HVO (hydrotreated vegetable oils), e-Fuels (electrofuels) or CTL (coal-to-liquid)
- **UK: BS 2869 A1 / A2**
- **USA: ASTM D 975-09a 1-D S15 or 2-D S15**
- **USA: ASTM D 975-09a 1-D or 2-D** (only for engines without diesel oxidation catalyst (DOC)) For details on equipping with a DOC, see chapter 4.2.1 *Engine serial number, page 26.*
- **Japan: JIS K 2204** (with a maximum HFRR value of 520 µm)

<b>CAUTION</b>	
	<p><b>Danger of engine damage from low quality fuel.</b></p> <p>The use of fuel that does not meet the specifications can lead to engine damage.</p> <ul style="list-style-type: none"> <li>▪ The use of fuels that do not meet specifications require approval by Motorenfabrik HATZ (main plant).</li> </ul>

**CAUTION****Danger of malfunctions due to old fuel.**

When diesel fuel is stored in a fuel tank or canister for lengthy periods, deposits may form on account of fuel aging. These deposits result in malfunctions due to clogged fuel filters and damage to the injection system.

- Perform the prescribed storage steps in machines that will be out of use for more than three months (see chapter *10.1 Storing the machine, page 137*).
- Only refuel with fresh diesel fuel such as can be obtained from filling stations.

**Winter fuel**

Diesel fuel loses its fluidity at low temperatures, which can lead to operating problems. Use cold-resistant winter diesel fuel for outside temperatures below 0 °C.

## 5 Engine overview

### 5.1 Designation of components

**Model – TIC**  
**intake side**

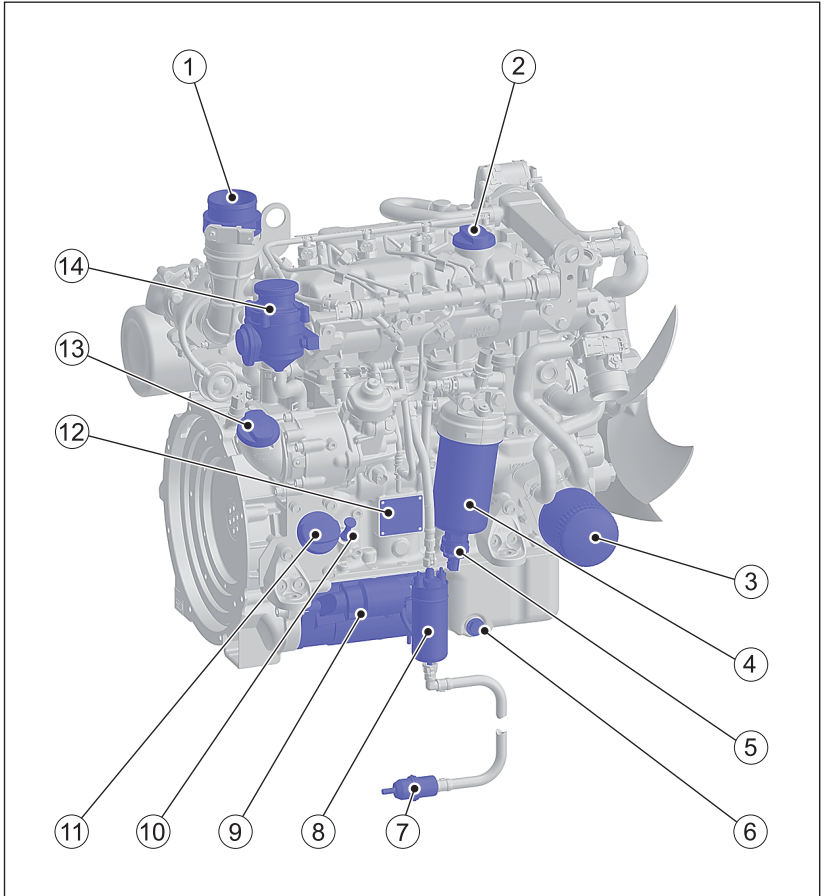

1	Intake opening for combustion air
2	Oil filler plug, top (option)
3	Oil filter
4	Main fuel filter
5	Drain screw with integrated water in fuel sensor
6	Side oil drain screw

7	Fuel prefilter
8	Electric fuel pump
9	Starter (low mounting position)
10	Dipstick
11	Oil filler plug, bottom
12	Engine type plate
13	Oil filler plug, middle (option)
14	Crankcase ventilation

**Model – TIC/TICD**  
**exhaust side**

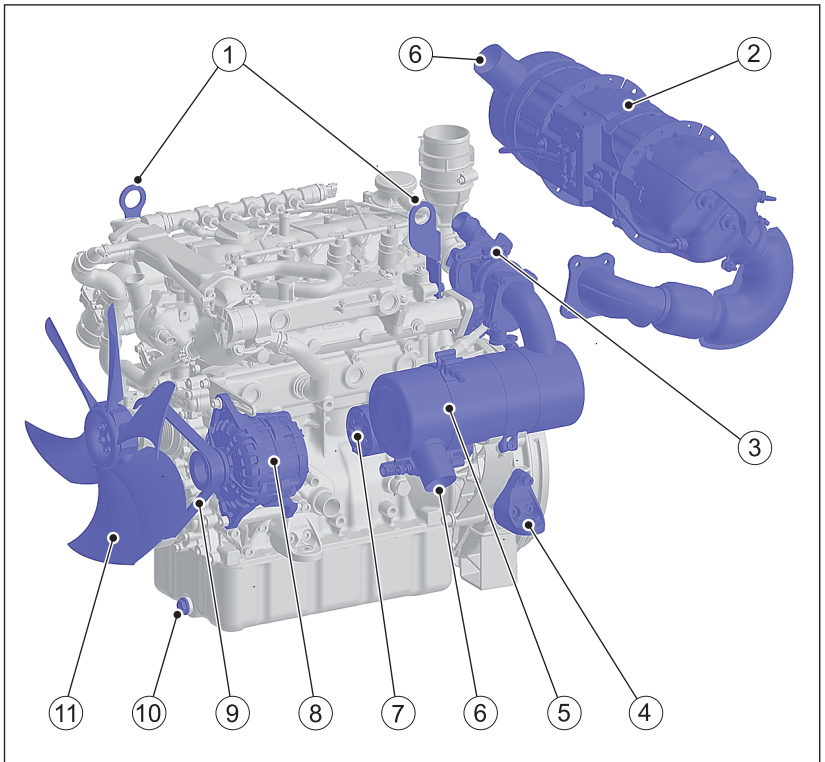

1	Lifting eyes
2	DPF system with diesel oxidation catalytic converter and diesel particulate filter (TICD model)
3	Turbocharger
4	Engine foot
5	Diesel oxidation catalytic converter DOC (TIC model)
6	Exhaust outlet
7	Starter (high mounting position)
8	Three phase alternator
9	Poly v belt
10	Oil drain screw, front
11	Fan



**Model – OPU**  
**intake side**

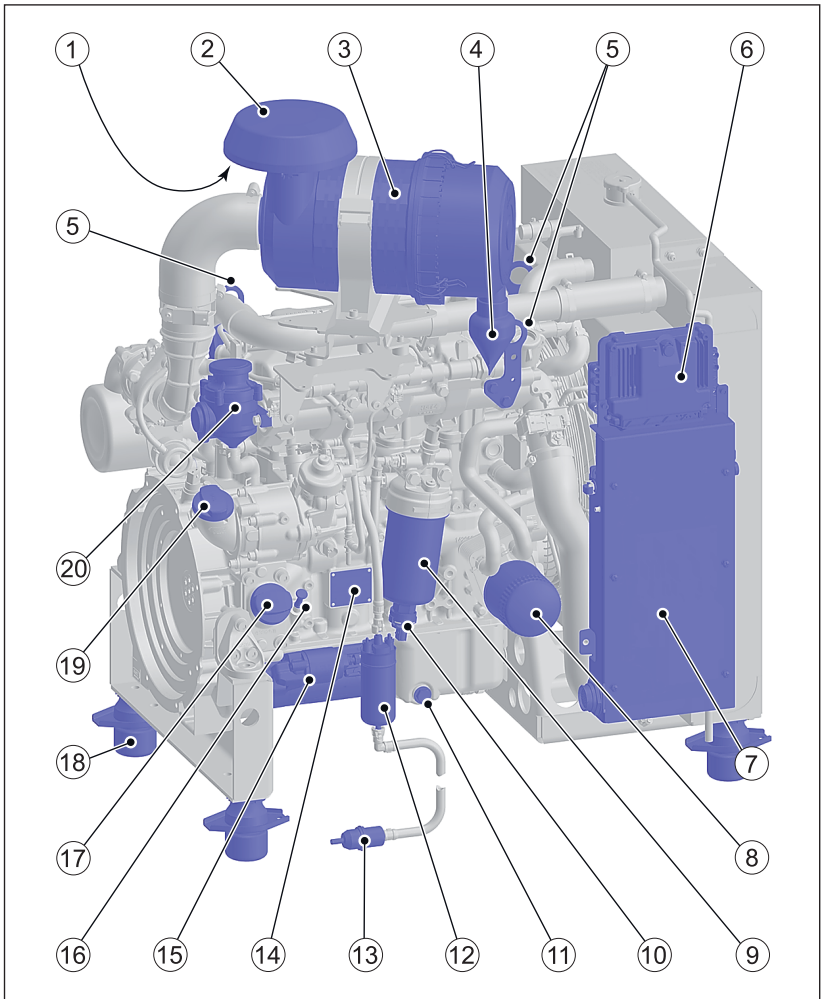

**NOTICE**



The Open Power Unit (OPU) is a complete system which, in addition to the engine, also includes all of the components required for cooling.

1	Intake opening for combustion air
2	rain cap

3	Air filter (optional)
4	Dust discharge valve
5	Lifting eyes
6	Engine control unit
7	Plug holder with integrated relay, glow control unit and fuse holder
8	Oil filter
9	Main fuel filter
10	Drain screw with integrated water in fuel sensor
11	Side oil drain screw
12	Electric fuel pump
13	Fuel prefilter
14	Engine type plate
15	Starter (low mounting position)
16	Dipstick
17	Oil filler plug, bottom
18	Vibration damper
19	Oil filler plug, middle (option)
20	Crankcase ventilation

**Model – OPU**  
**exhaust side**

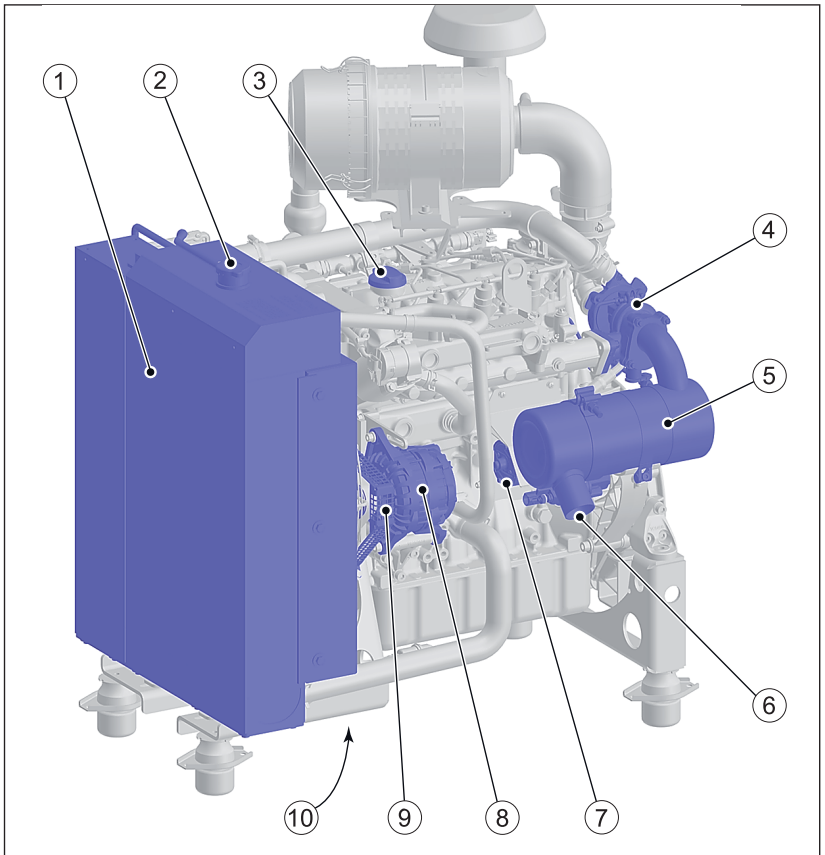

1	Radiator with integrated expansion tank
2	Sealing cap for coolant
3	Oil filler plug, top (option)
4	Turbocharger
5	Diesel oxidation catalyst (DOC)
6	Exhaust outlet
7	Starter (high mounting position)
8	Three phase alternator
9	Belt guard (option)
10	Oil drain screw, front

**Encapsulated model – Silent Pack**

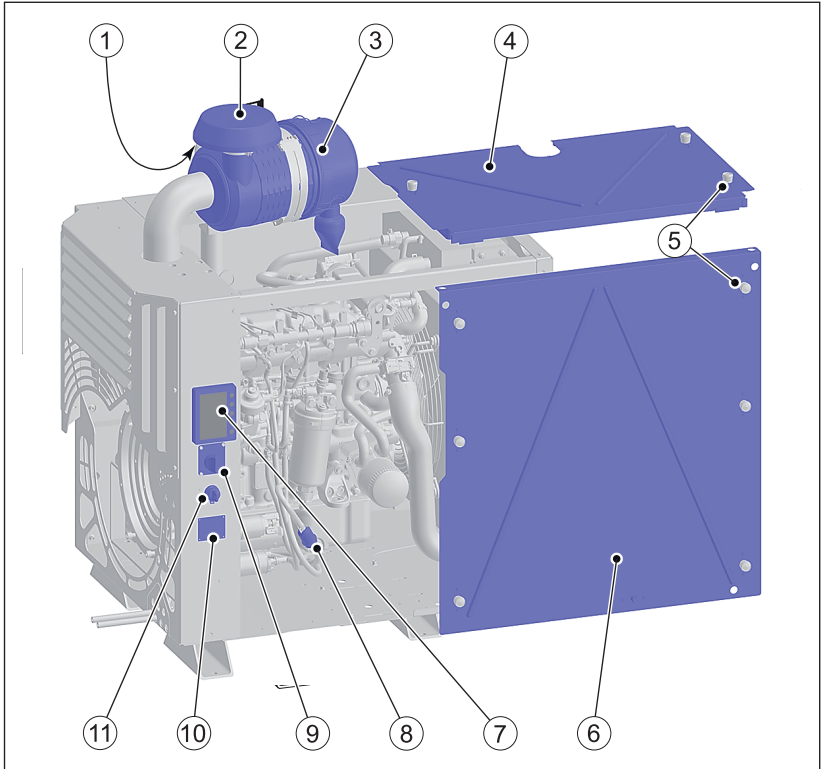

**NOTICE**



The Silent Pack is an Open Power Unit (OPU) that is surrounded by a noise and weather protection capsule. The maintenance covers (4) and (6) can be removed for daily maintenance work. The individual maintenance positions are shown on the figures of the OPU.



1	Intake opening for combustion air
2	rain cap
3	Air filter (optional)
4	Top maintenance cover
5	Clamp-type fasteners
6	Side maintenance cover
7	HATZ Smart Panel (HSP)

8	Fuel prefilter
9	Speed control (option)
10	Engine type plate
11	Ignition lock

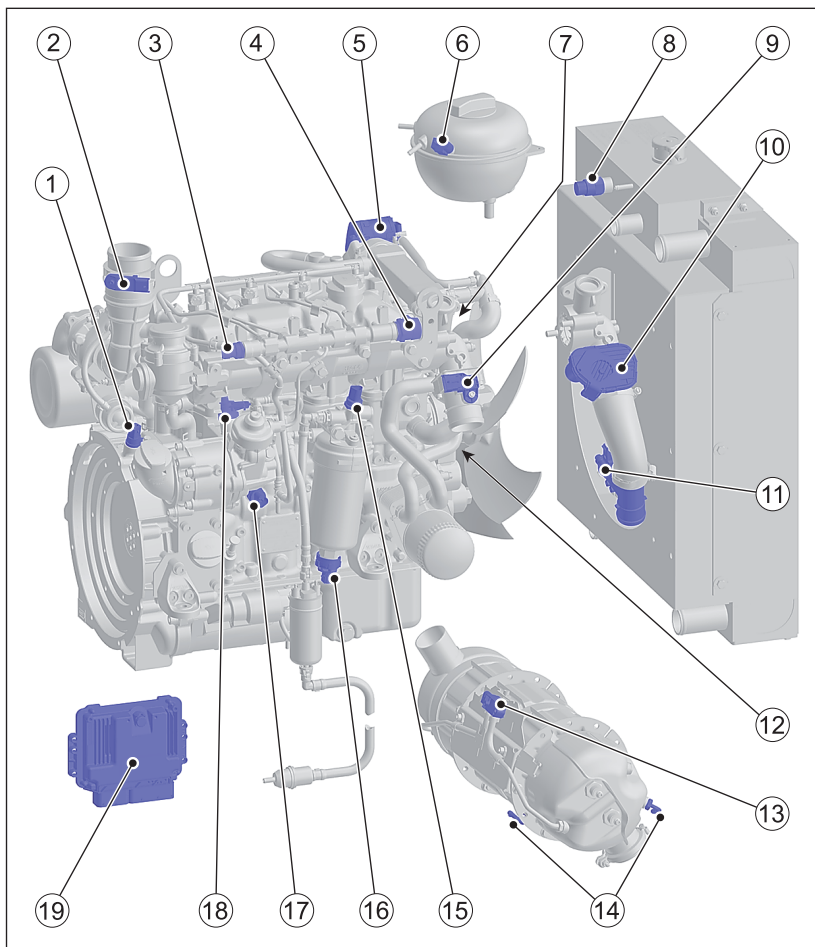
**Components of the electronic engine control unit**

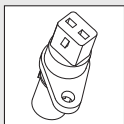

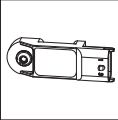
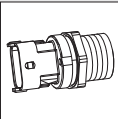
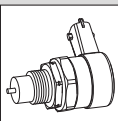
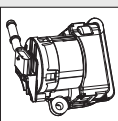
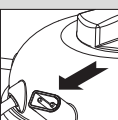
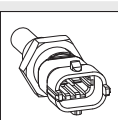
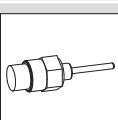
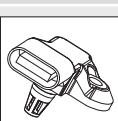
Pos.	Designation	Figure
1	Crankshaft speed sensor	

Pos.	Designation	Figure
2	Air filter differential pressure sensor	
3	Rail pressure sensor	
4	Rail pressure control valve	
5	EGR valve	
6	Coolant level sensor (integrated in external expansion tank)	
7	Coolant temperature sensor	
8	Coolant level sensor (for cooler with integrated expansion tank)	
9	Charge air pressure and charge air temperature sensor	
10	Intake throttle (TICD model)	

Pos.	Designation	Figure
11	Air mass meter (TICD model)	A cylindrical air mass meter with a sensor probe extending from the top and a mounting bracket on the side.
12	Camshaft sensor	A cylindrical camshaft sensor with a central probe and a mounting bracket.
13	Differential pressure sensor (TICD model)	A rectangular differential pressure sensor with two ports and a mounting bracket.
14	Exhaust gas temperature sensor (TICD model)	A long, thin exhaust gas temperature sensor with a protective sheath and a mounting bracket.
15	Low fuel pressure and fuel temperature sensor	A cylindrical low fuel pressure and fuel temperature sensor with a central probe and a mounting bracket.
16	Water in fuel sensor	A cylindrical water in fuel sensor with a central probe and a mounting bracket.
17	Oil pressure and oil temperature sensor	A cylindrical oil pressure and oil temperature sensor with a central probe and a mounting bracket.
18	Metering unit on the high-pressure pump	A complex metering unit on the high-pressure pump with multiple ports and a mounting bracket.
19	Ambient pressure sensor (integrated in the engine control unit)	A rectangular ambient pressure sensor with a mounting bracket.

## 5.2 Fuses

### Overview - fuse assignment

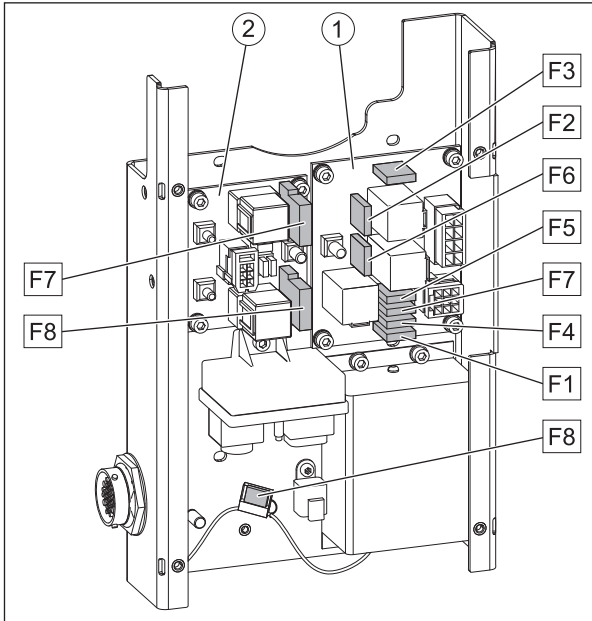

Pos.	Consumer	Fuse
<b>1</b>	<b>Central electrical system</b>	
F1	Signal inputs for control unit	5 A
F2	Fuel pump	10 A
F3	Glow plugs	40 A
F4	Voltage supply for control unit	15 A
F5	Ignition, terminal 15	10 A
F6	Starter, terminal 50	30 A
F7	Ignition, terminal 15 (for additional consumers that are switched via the ignition lock)	4 A
F8	Voltage converter (only for 24 V system)	15 A
<b>2</b>	<b>Power module (option)</b>	
F7	Exhaust gas heating 1	50A
F8	Exhaust gas heating 2	50A



## 5.3 Hatz Smart Panel (HSP)

### Overview

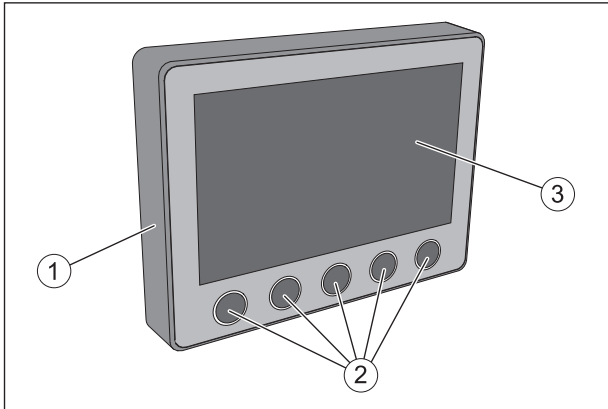

1	Housing
2	Function keys
3	Display

### 5.3.1 Main menu

#### Overview

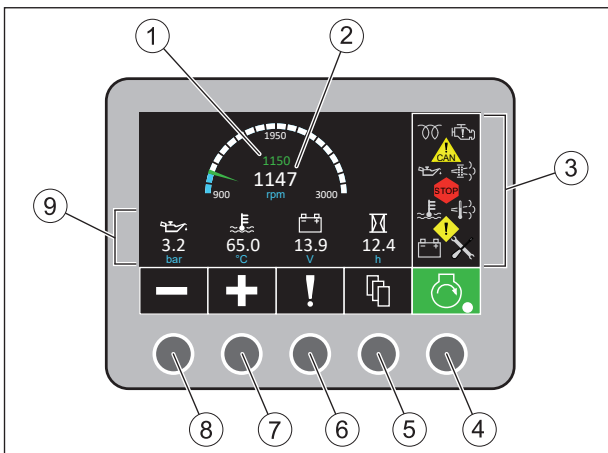

1	Preselected engine speed indicator
2	Actual engine speed
3	Warning and indicator lamps

4	Button for START – STOP Only in model "Engine start/engine stop via CAN bus"
5	Menu selection key
6	Button for calling up the diagnostic trouble codes
7	Button for speed increase
8	Button for speed reduction
9	Information line

### Engine speed





The buttons (7) and (8) can be used to preset the desired speed while the engine is switched off or to adjust the speed while the engine is running. Pos. (1) shows the preset engine speed, and pos. (2) shows the actual engine speed.











### Information line







Displays the current values for:



- Engine oil pressure
- Coolant temperature
- System voltage
- Operating hours

### Explanation of symbols

Symbol	Meaning
	<b>"Engine switched off" indicator</b> (red) The engine is in standby or automatic mode. Only in model "Engine start/engine stop via CAN bus".
	<b>"Engine in operation" indicator</b> (green) The engine is running. Only in model "Engine start/engine stop via CAN bus".
	<b>Menu selection</b> The following menus are available for selection: <ul style="list-style-type: none"> <li>▪ Current Values (page 1-3)</li> <li>▪ Regeneration (only in engine specification TICD)</li> <li>▪ Diagnostic Trouble Codes (active + historical)</li> <li>▪ Page Selection</li> </ul>
	<b>Diagnostic Trouble Codes</b> Displays the active and historical diagnostic trouble codes.

Symbol	Meaning
	<b>Speed increase</b> Only in model with variable speed.
	<b>Speed reduction</b> Only in model with variable speed.
	<b>Warning and indicator lamps:</b>
	<b>Pre-glow indicator</b> Lights up at engine temperatures below 30 °C. Start the engine after the indicator has gone out.
	<b>Oil pressure indicator</b> Engine oil pressure too low. Danger of engine damage. Switch off the engine immediately and check the oil level. Contact <b>HATZ Service</b> if the oil level is correct.
	<b>Coolant temperature indicator (orange)</b> Increased coolant temperature. Operate engine at reduced load. Stop the engine if the engine temperature indicator has not gone out after 5 minutes.
	<b>Coolant temperature indicator (red)</b> Coolant temperature is impermissibly high. Switch off the engine immediately! Danger of engine damage.
	<b>Charge control</b> Fault in the alternator or alternator charging circuit. The battery is no longer charged. Eliminate the fault immediately.
	<b>Fault lamp – CAN</b> Problem with the CAN connection.
	<b>Fault lamp – STOP</b> The engine changes to emergency mode or switches off automatically.
	<b>Error lamp – warning</b>

Symbol	Meaning
	<p><b>Engine malfunction</b></p> <p>This indicator lights up if there an engine malfunction. Change to the diagnostic trouble code page for a fault diagnosis; see section 9.2 <i>Diagnostic trouble codes in case of engine malfunctions</i>, page 131.</p> <p>If the engine malfunction persists, contact a HATZ service center immediately.</p> <p>Depending on the engine specification, the engine controller reacts as follows in case of a malfunction:</p> <ul style="list-style-type: none"> <li>▪ <b>Emergency operation</b> The engine switches to emergency mode. In this situation, the available engine torque is reduced and the speed is limited to max. 1900 rpm. <b>WARNING!</b> To avoid secondary damage, the engine may only be operated in emergency mode for a very short period, e.g., to move the machine away from a critical location. Avoid staying in the vicinity of the running engine if possible. Switch off the engine and correct the fault promptly or contact a HATZ service center.</li> <li>▪ <b>Engine stop</b> The engine switches off automatically.</li> </ul>
	<p><b>Regeneration of diesel particulate filter required</b></p> <ul style="list-style-type: none"> <li>▪ Automatic or manual regeneration is requested.</li> </ul>
	<p><b>Regeneration of diesel particulate filter required</b></p> <ul style="list-style-type: none"> <li>▪ Start automatic or manual regeneration "<b>immediately</b>".</li> </ul> <p>The soot concentration in the particle filter has already reached an increased value.</p>
	<p><b>Regeneration of the diesel particulate filter has started</b></p>
	<p><b>Warning of very hot engine exhaust gases</b></p> <p>This indicator warns against injuries and the danger of fire due to very high temperatures during regeneration.</p> <p>Note the safety instructions (see section 7.7 <i>Regenerating the diesel particulate filter</i>, page 73).</p>
	<p><b>Regeneration of the diesel particulate filter was blocked.</b></p>

Symbol	Meaning
	<b>Regeneration of the diesel particulate filter was blocked.</b> Orange → Soot particle filter load is high
	<b>Service interval indicator</b> The 500-hour service is due. After completion of the service work, reset the service interval indicator, see section 8.2.18 <i>Resetting the service interval indicator</i> , page 125.
	<b>Air filter service indicator</b> Clean or replace the filter cartridge. <i>Note:</i> This symbol lights up when activated instead of the service interval indicator.

### 5.3.2 Menu – Current Values

#### Overview

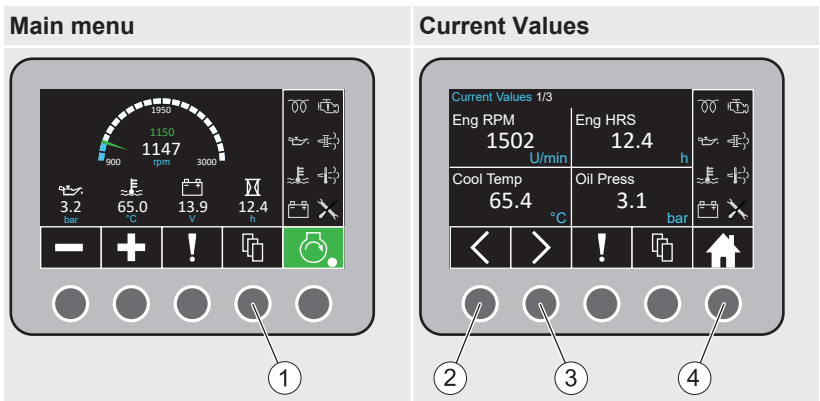

1	Menu selection key
2	Page back
3	Page forward
4	Home (back to main menu)

## Procedure

Step	Activity
1	Press the button for the menu selection (1). The display changes to the "Current Values" menu. This menu consists of 3 pages.
2	Select the desired page using the buttons (2) and (3).
3	Pressing the home button (4) returns the display to the main menu.

## Indicators

Depending on the configuration, the following values can be displayed:

- Eng RPM (engine speed)
- Eng HRS (operating hours)
- Cool temp (coolant temperature)
- Oil Press (engine oil pressure)
- Oil Temp (engine oil temperature)
- V-Syst (system voltage)
- Charge Air Temp (charge air temperature)
- Cons./hrs. (fuel consumption per hour)
- Torque (absolute)
- Torque (refers to the maximum engine torque)
- Torque@RPM (refers to the maximum engine torque at the current engine speed)
- Fuel Temp (fuel temperature)
- Amb Press (barometric air pressure)
- Inject Qty (injection quantity)
- Charge Pressure
- Charge Air Temp (charge air temperature)
- HRS to Service (operating hours remaining until the next major service)



### 5.3.3 Menu – General Settings

The following settings can be adjusted:

- Brightness
- Language
- Units

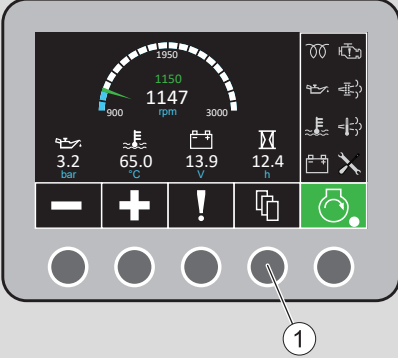
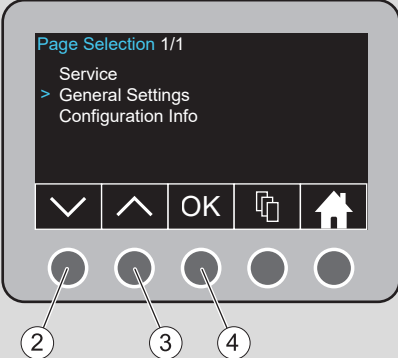
#### Procedure

Step	Activity	Figure
1	In the <b>main menu</b> , press the button for menu selection (1) repeatedly until the <b>Page Selection</b> menu appears.	<p><b>Main menu</b></p>  <p>The main menu display shows a tachometer at 1150 rpm, fuel pressure at 3.2 bar, temperature at 65.0 °C, voltage at 13.9 V, and hours at 12.4 h. A row of five buttons is at the bottom: minus, plus, exclamation mark, menu selection (1), and a green button with a gear icon.</p>
2	Using buttons (2 or 3), select the <b>General Settings</b> menu and confirm with OK (button 4).	<p><b>Page Selection</b></p>  <p>The Page Selection menu shows 'Page Selection 1/1' with options: Service, &gt; General Settings, and Configuration Info. A row of five buttons is at the bottom: down arrow (2), up arrow (3), OK (4), menu selection, and home.</p>

Step	Activity	Figure
3	Use the buttons (2 or 3) to change to the desired selection (e.g. language) and confirm with OK (button 4).	<p><b>General Settings</b></p> 
4	<p>Using buttons (2 or 3), select the desired language and confirm with OK (button 4). Proceed in the same way to change the brightness or units.</p> <p>Pos. 5 = ESC (return to Page Selection).</p> <p>Pos. 6 = Home (return to main page).</p>	<p><b>Language</b></p> 



## 6 Transport, installation and commissioning

### 6.1 Transport

#### Safety notes



#### WARNING



#### Danger of injury from improper lifting and transport.

Danger of crushing from the engine falling or tipping.

- The machine may only be lifted using the lifting points (1).
- Before lifting the engine, check the lifting eyes for deformation and damage. Lifting with deformed or damaged lifting eyes is not permitted. Replace deformed or damaged lifting eyes before using them for lifting.
- Before lifting the engine, ensure that the fixing screws of the lifting eyes are tight.
- Only use a suitable hoist with a sufficient carrying capacity.
- Always use all lifting eyes for lifting.
- Do not remain under suspended loads.



#### CAUTION



#### Only use the lifting eye for transporting the engine.

Do not use for lifting the entire machine.



#### CAUTION



#### Danger of injury from overloading the body.

Lifting the machine to transport it or to move it to another location can lead to injuries (of the back, for example).

- Only lift the machine with a hoist.

#### NOTICE



#### Danger of environmental damage from leaking fluid.

If the machine is tilted, engine oil and fuel can run out.

- Only transport the machine in an upright position.

## Access to the lifting eyes with the Silent Pack

### Overview

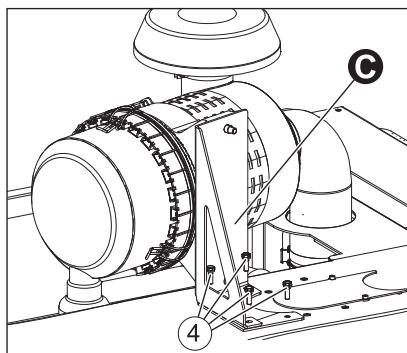
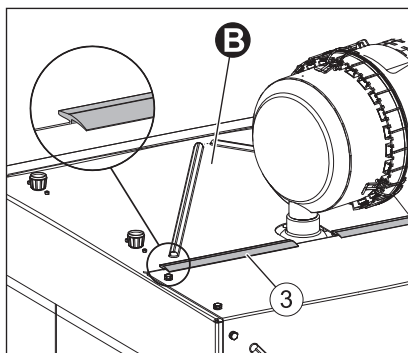
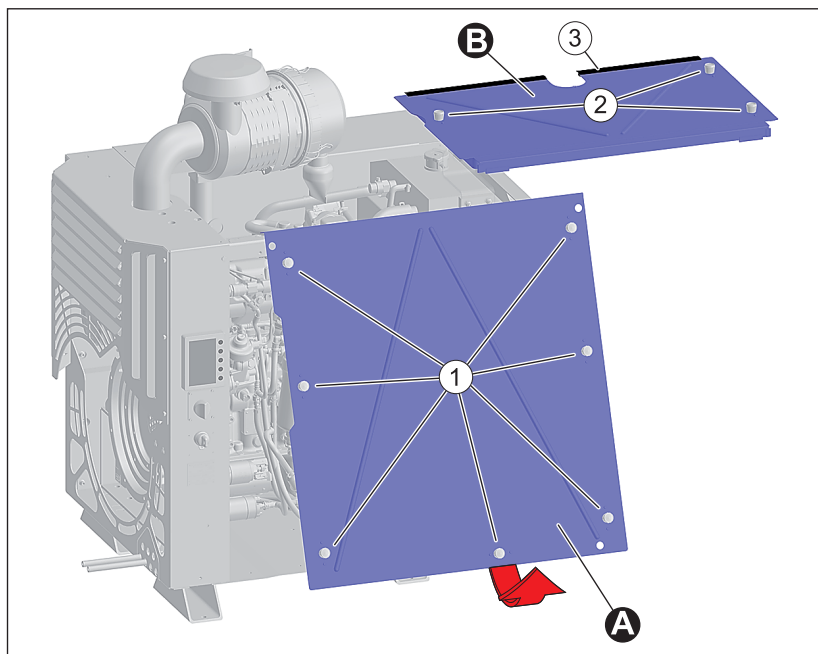

<b>A</b>	Control side maintenance lid
<b>B</b>	Top maintenance cover
<b>C</b>	Bracket for the air filter
<b>1</b>	Clamp-type fasteners for control side maintenance cover
<b>2</b>	Clamp-type fasteners for top maintenance cover

3	Sealing lip
4	Fixing screws for bracket for the air filter (4 pieces)

### Procedure

Step	Activity
1	Turn clamp-type fasteners (1) to the left up to the stop. Tip maintenance cover on the bottom to the outside and lift away upwards.
2	Turn clamp-type fasteners (2) to the left up to the stop and then remove the maintenance cover.
3	Unscrew the fixing screws (4).
4	Position of the lifting eyes, see section <i>lifting points (engines with 3 lifting eyes)</i> in this chapter.
5	Mount all parts again after completing the transport activities. Make sure that the seal lip (3) of the maintenance cover (B) is not trapped!

### Lifting points (engines with 2 lifting eyes)

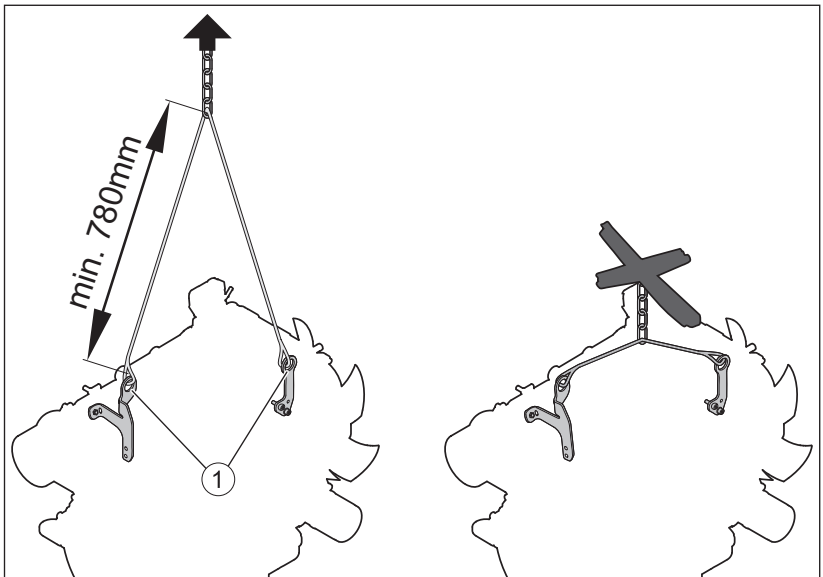

1 Lifting points

### Lifting points (engines with 3 lifting eyes)

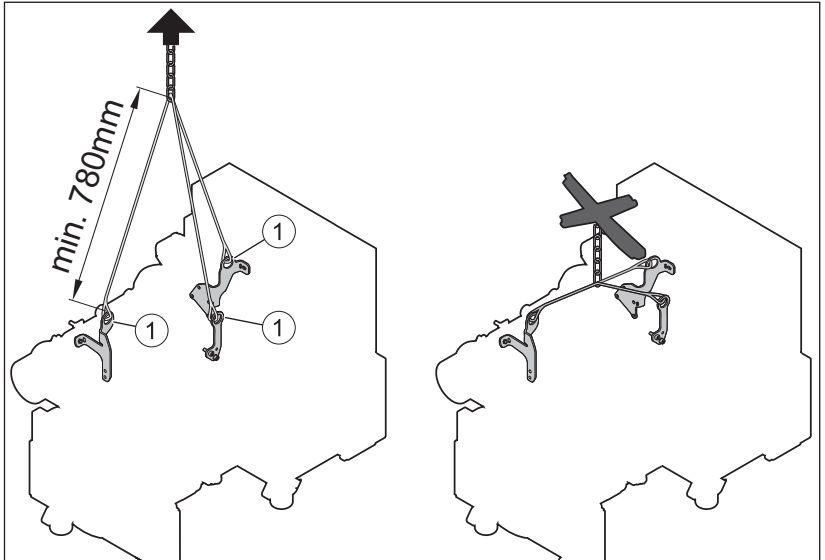

1 Lifting points

#### Transport conditions

- When transporting the machine, follow the safety instructions.
- When transporting, follow the applicable safety and accident prevention regulations.
- After delivery, check the machine for completeness and transport damage.
- Only transport the machine when it is switched off and has cooled down.
- If you have questions on transporting the machine, please contact your nearest **HATZ service station**. For contact data, see chapter 1 *Legal notices*, page 5 or [www.hatz-diesel.com](http://www.hatz-diesel.com).

## 6.2 Installation notes

HATZ diesel engines are efficient, robust, and have a long service life. Therefore, they are usually installed in machines that are used for commercial purposes.

The machine manufacturer must follow the applicable regulations regarding machine safety – the engine is a part of a machine.

Depending on the use and installation of the engine, it may be necessary for the machine manufacturer and machine user to install safety equipment to prevent inappropriate use. Note the following:

- Parts of the exhaust gas system and the engine surface become hot during operation and may not be touched until they cool down after the engine is switched off.
- Incorrect cable connections and incorrect operation of the electrical equipment can lead to sparking and must be avoided.
- After the engine is installed in the machine, rotating parts must be protected against contact.  
HATZ safety equipment is available for the belt drive of the cooling fan and alternator.
- Comply with all notices and warning labels on the engine and keep them in a legible condition. If an adhesive label should become detached or difficult to read, it must be replaced promptly. For this purpose, contact your nearest **HATZ service station**.
- Any improper modification of the engine will result in a loss of liability coverage for resulting damage.

Only regular maintenance, as specified in this manual, will maintain the operating readiness of the engine.

The **assembly instructions** contain important information on how to safely assemble the engine. They are available from any **Hatz service station**.

### NOTICE



**Connection and wiring plans** can be viewed at [www.hatz.com/docu](http://www.hatz.com/docu) after entry of the engine serial number located on the type plate directly on the engine.

If you have any questions, please contact your nearest **HATZ Service** before commissioning the engine.

## 6.3 Preparations for commissioning

- Check the delivered parts for completeness, damage, and other noticeable issues.
- Ensure that the setup location is adequately ventilated.



### DANGER



#### Danger to life from inhaling exhaust gases.

Toxic engine exhaust gases can lead to loss of consciousness, and even death, in closed-off and poorly ventilated rooms.

- Never operate the machine in closed-off or poorly ventilated rooms.
- Do not breathe in the exhaust gases.

## 6.4 Filling engine oil (first filling)

Engines are normally delivered without an engine oil filling.

### Safety note

#### CAUTION

##### Danger of later engine damage.

- Operating the engine with an oil level below the **min.** mark or above the **max.** mark can lead to engine damage.
- When checking the oil level, the engine must be horizontal and have been switched off for a few minutes.

### Overview

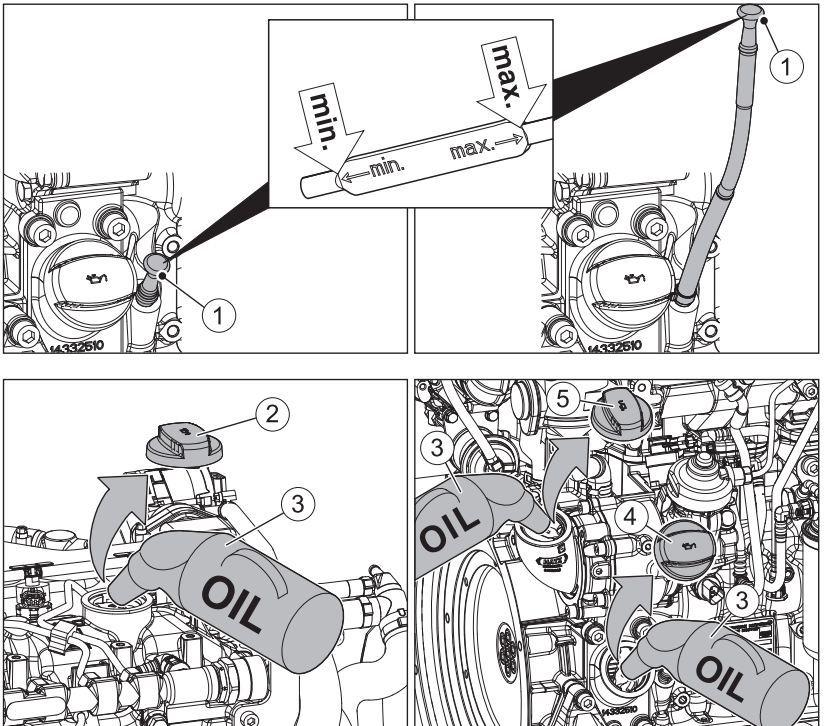



1	Dipstick (depending on the model)
2	Oil filler plug, top (option)
3	Oil refilling container
4	Oil filler plug, bottom
5	Oil filler plug, middle (option)

## Procedure

Step	Activity
1	Pull out the dipstick (1) and clean it.
2	Depending on the model, unscrew oil filler plug (2), (4) or (5).
3	Fill with engine oil. For the specification and viscosity, see section 4.3 <i>Engine oil</i> , page 27. For the filling quantity, see section 4.1 <i>Engine information and filling quantities</i> , page 21.
4	Reinsert the dipstick.
5	Pull out the dipstick and check the oil level.
6	If required, add engine oil to the max. mark.
7	Reinsert the dipstick.
8	Screw in the oil filler plug.

## 6.5 Filling the cooling system

### Safety notes

 <b>CAUTION</b>	
 	<p><b>Danger of burns.</b></p> <p>There is a danger of burns when working on a hot cooling system. The cooling system is pressurized when the engine is hot.</p> <ul style="list-style-type: none"> <li>▪ Let the engine cool.</li> <li>▪ Wear safety gloves.</li> </ul>
<b>CAUTION</b>	
	<p><b>Danger of later engine damage.</b></p> <ul style="list-style-type: none"> <li>▪ Operating the engine with a coolant level below the <b>MIN.</b> mark can lead to engine damage.</li> <li>▪ When checking the coolant level, the engine must be horizontal and switched off.</li> </ul>

## Overview

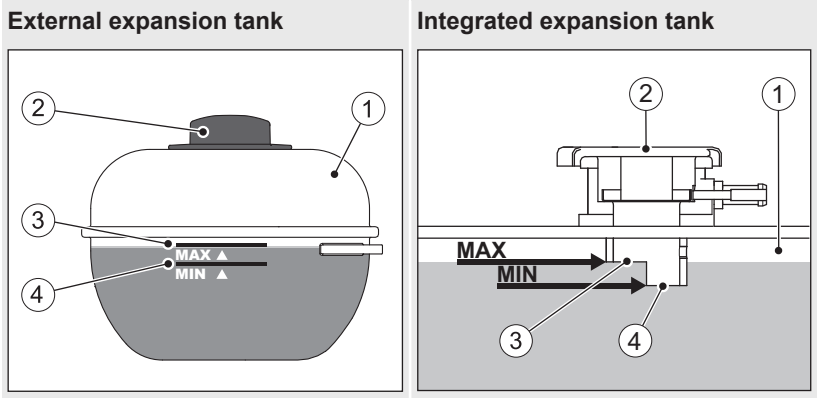

1	Expansion tank for coolant
2	Sealing cap
3	<b>MAX</b> - Maximum coolant level
4	<b>MIN</b> - Minimum coolant level

## Procedure

Step	Activity
1	Open the sealing cap (2).
<b>HATZ cooler with integrated expansion tank</b>	
2	Top up the coolant to the edge (3) of the pipe section. For preparation of the coolant, see section 4.4 <i>Coolant</i> , page 28.
<b>HATZ cooler with external expansion tank</b>	
2	Top up the coolant to the <b>MAX</b> mark on the expansion tank. For preparation of the coolant, see section 4.4 <i>Coolant</i> , page 28.
3	Tighten the sealing cap (2) all the way by hand.
4	Start the engine (see chapter 7 <i>Operation and use</i> , page 63).
5	Warm up the engine until the coolant has reached a temperature of approx. 85 °C. Above this temperature the coolant is pumped through the entire cooling system and forces out remaining air bubbles.
6	Switch off the engine and let it cool down completely (see chapter 7 <i>Operation and use</i> , page 63).



Step	Activity
7	Check the coolant level again. The coolant must be seen between the <b>MIN</b> and <b>MAX</b> mark; for a warm engine the level can also be slightly above the <b>MAX</b> mark.
8	Check the cooling system for leaks, retighten the hose clips if necessary (see section 8.2.5 <i>Check the cooling system, page 90</i> ).

## 6.6 Venting the fuel system

### Requirements

The fuel system must be bled in the following situations:

- At first filling of the fuel tank
- After the fuel prefilter or main fuel filter is replaced
- Engine shuts down due to empty fuel tank

### Overview

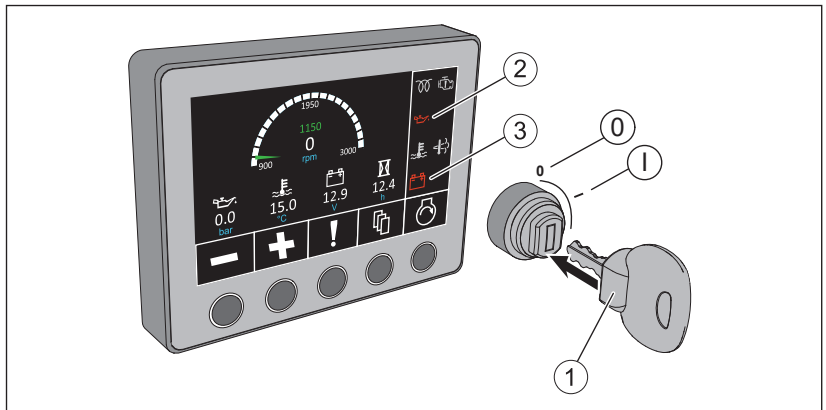

1	Starting key
2	Oil pressure indicator
3	Charge control
Ignition lock	
0	Off
I	Operation

**Procedure**

<b>Step</b>	<b>Activity</b>
1	Insert the starting key all the way and turn to position "I". The oil pressure indicator (2) and charge control (3) light up.
2	Leave the starting key at position "I" until you hear the electrical fuel feed pump switch off (approx. 30 seconds).
3	Turn the starting key back to position "0". <i>Note:</i> Carry out steps 2 and 3 several times to press the air out of the fuel system.
4	Start the engine, see section 7 <i>Operation and use</i> , page 63.

## 7 Operation and use

### 7.1 Safety notes

#### NOTICE



#### Comply with the safety chapter!

Follow the basic safety instructions in chapter 3 *Safety*, page 7.



#### WARNING



#### Danger of injury from damage and defects on the machine.

- Do not take the machine into service if damage has been localized and identified.
- Replace defective components.



#### WARNING



#### Danger of injury from failure to follow the operating instructions and from performing unauthorized tasks on the machine.

- Define the responsibilities of the personnel taking the machine into service.
- Replace defective machine parts immediately.
- Check the installation conditions when the machine is first taken into service and after the machine has been inactive for a lengthy period.



#### WARNING





#### Danger of injury during emergency operation due to engine damage and defects.

The engine fault indicator lights up or flashes.

- To avoid secondary damage, the engine may only be operated in emergency mode for a very short period, e.g., to move the machine away from a critical location. For details on engine faults and fault diagnosis, see chapter 5.3 *Hatz Smart Panel (HSP)*, page 45.
- Avoid staying in the vicinity of the running engine if possible.
- Switch off the engine and correct the fault promptly or contact a HATZ service center.

<b>CAUTION</b>	
	<p><b>Danger of engine damage from low load operation.</b></p> <p>Operating the engine at no load or at very low load for an extended period can impair the running characteristics of the engine.</p> <ul style="list-style-type: none"> <li>▪ Make sure that the engine load is at least 15 %.</li> <li>▪ Before switching off the engine following low load operation, briefly operate it at a considerably higher load.</li> </ul>

### Additional safety instructions for the first commissioning

 <b>CAUTION</b>	
	<p><b>Health hazard due to inhalation of flue gas.</b></p> <p>To protect exposed metal parts against corrosion, the parts concerned are coated with a protective wax. When the engine is started for the first time, this protective wax evaporates on hot components. This can lead to the generation of smoke for a brief period.</p> <ul style="list-style-type: none"> <li>▪ Do not inhale flue gas.</li> <li>▪ Ensure sufficient ventilation.</li> </ul>

## 7.2 Performing tests

### Before starting

Before starting the engine, several tests need to be performed to ensure the machine is working properly.



### Procedure

Step	Test
1	The machine is standing securely and on a level surface.
2	The installation location is adequately ventilated.
3	There is a sufficient amount of fuel in the fuel tank (see chapter 7.6 <i>Refueling</i> , page 72).
4	There is a sufficient amount of engine oil in the engine housing (see chapter 7.5 <i>Check the oil level</i> , page 70).
5	There is a sufficient amount of coolant in the expansion tank (see chapter 8.2.5 <i>Check the cooling system</i> , page 90).
6	Cooler and cooler hoses are free from leaks (see chapter 8.2.5 <i>Check the cooling system</i> , page 90).
7	No persons are located in the danger zone of the engine or machine.

Step	Test
8	All safety equipment is in place.

### 7.3 Starting the engine

#### Safety notes

 <b>DANGER</b>	
	<p><b>Danger to life from inhaling exhaust gases.</b></p> <p>Toxic engine exhaust gases can lead to loss of consciousness, and even death, in closed-off and poorly ventilated rooms.</p> <ul style="list-style-type: none"> <li>▪ Never operate the machine in closed-off or poorly ventilated rooms.</li> <li>▪ Do not breathe in the exhaust gases.</li> </ul>
<b>CAUTION</b>	
	<p><b>Danger of engine damage from the use of starting fluid.</b></p> <ul style="list-style-type: none"> <li>▪ Engine damage from the use of starting fluid can lead to uncontrolled ignition.</li> <li>▪ Engine damage from uncontrolled ignition.</li> <li>▪ Never use starting fluid.</li> </ul>
<b>NOTICE</b>	
	<p>See also starting instructions in the documentation for the complete machine.</p>

#### Overview – Hatz Smart Panel

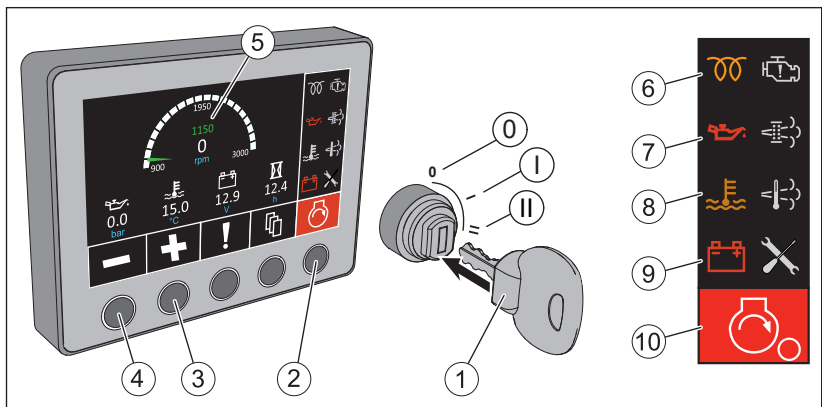

1	Starting key
2	Button for START – STOP Only in model "Engine start/engine stop via CAN bus" (see also <i>Explanation of symbols</i> section 5.3.1 <i>Main menu</i> , page 45)
3	Speed increase Only in model with variable speed
4	Speed reduction Only in model with variable speed
5	Preselected engine speed indicator
6	Pre-glow indicator
7	Oil pressure indicator
8	Coolant temperature indicator
9	Charge control
10	"Engine switched off" indicator (red) The engine is in standby or automatic mode. Only in model "Engine start/engine stop via CAN bus"
Ignition lock	
0	Off
I	Operation
II	Start

### NOTICE



For further details on the CAN display, see section 5.3 *Hatz Smart Panel (HSP)*, page 45.

### Procedure

### NOTICE



- Start for max. 30 seconds. If the engine is still not running after that, turn the starting key back to position "0" and eliminate the cause (see chapter 9.1 *Troubleshooting*, page 128).
- Turn the starting key to position "0" every time you want to start the engine. The starter protection module prevents the starter from engaging while the engine is running and becoming damaged.

### Starting with the starting key

Step	Activity
1	<p>Insert the starting key all the way and turn to position "I".</p> <p>Depending on the model, the following indicators light up:</p> <ul style="list-style-type: none"> <li>▪ Pre-glow indicator (6)</li> <li>▪ Oil pressure indicator (7)</li> <li>▪ Charge control (9)</li> </ul> <p><i>NOTE:</i> When indicator (8) lights up, the coolant temperature is impermissibly high. Do not start the engine; eliminate the cause.</p> <p>When the pre-glow indicator goes out, continue with step 2.</p>
2	<p>Depending on the model, it may be possible to select the desired engine speed using buttons (3) and (4) before the engine starts. The selected speed (5) is shown in the display.</p>
3	<p>Turn the starting key to position "II".</p>
4	<p>As soon as the engine is running, release the starting key.</p> <ul style="list-style-type: none"> <li>▪ The starting key springs back to position "I" and remains in this position during operation.</li> <li>▪ The charge control (6) and oil pressure indicator (4) go out.</li> </ul>

### Starting on the Hatz Smart Panel

Only in model "Engine start/engine stop via CAN bus"

Step	Activity
1	<p>Insert the starting key all the way and turn to position "I".</p> <p>Depending on the model, the following indicators light up:</p> <ul style="list-style-type: none"> <li>▪ Pre-glow indicator (6)</li> <li>▪ Oil pressure indicator (7)</li> <li>▪ Charge control (9)</li> </ul> <p><i>NOTE:</i> When indicator (8) lights up, the coolant temperature is impermissibly high. Do not start the engine; eliminate the cause.</p> <p>When the pre-glow indicator goes out, continue with step 2.</p>
2	<p>Depending on the model, it may be possible to select the desired engine speed using buttons (3) and (4) before the engine starts. The selected speed (5) is shown in the display.</p>

Step	Activity
3	Press key (2). The engine starts automatically. The charge control (9) and oil pressure indicator (7) go out after the engine starts. The symbol (10) changes its color from red to green and thus indicates that the engine is running.

<b>NOTICE</b>	
	<ul style="list-style-type: none"> <li>▪ In case of irregularities, switch off the engine immediately.</li> <li>▪ Identify the fault and eliminate it.</li> <li>▪ For details of troubleshooting, see chapter 9.1 <i>Troubleshooting</i>, page 128.</li> </ul>

## 7.4 Switching off the engine

### Safety notes

<b>CAUTION</b>	
	<p><b>Danger of injury from unauthorized access.</b></p> <p>There is a danger of injury if unauthorized persons handle the machine.</p> <ul style="list-style-type: none"> <li>▪ Protect the starting key against unauthorized access during breaks in operation or after completing work.</li> </ul>

<b>CAUTION</b>	
	<p><b>Danger of engine damage from overheating.</b></p> <p>The switching off of the engine after high engine load or at high coolant temperature (engine temperature indicator lights up) can lead to engine damage due to heat accumulation.</p> <ul style="list-style-type: none"> <li>▪ Allow the engine to cool down for approx. 5 min at reduced speed and load.</li> </ul>

<b>NOTICE</b>	
	<p><b>Danger of exhaustive battery discharge.</b></p> <ul style="list-style-type: none"> <li>▪ When the machine is switched off, always turn the starting key to position "0" or else the battery may become fully discharged.</li> </ul>

<b>NOTICE</b>	
	<p>See also instructions in the documentation for the complete machine.</p>



## Overview – Hatz Smart Panel

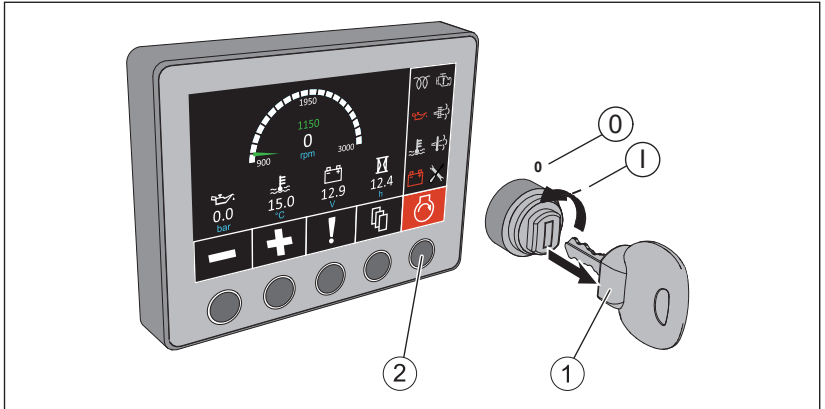

1	Starting key
2	Button for START – STOP Only in model "Engine start/engine stop via CAN bus" (see also <i>Explanation of symbols</i> section 5.3.1 <i>Main menu</i> , page 45)
Ignition lock	
0	Off
I	Operation

### NOTICE



After the engine is switched off, the engine control unit requires voltage for a short period to close internal processes. When using a battery main switch, wait at least 30 seconds after switching the engine off before using the battery main switch. Otherwise, the engine control unit will output an error message the next time it starts.

### Switching off the engine with the starting key

Step	Activity
1	Turn the starting key (1) to position "0". The engine switches off. The display switches off after approx. 20 seconds. <i>Note:</i> The engine continues running for several seconds after it is switched off. Before performing any further activities, wait until all moving components have come to a complete standstill.
2	Remove the starting key.



## Switching off the engine with the Hatz Smart Panel

Only in model "Engine start/engine stop via CAN bus"

Step	Activity
1	<p>Press key (2).</p> <p>The engine switches off and is then in standby or automatic mode. The display remains active. The engine control unit is not switched off until the starting key (1) is in position "0" (see also the documentation on the entire machine).</p> <p>Alternatively, the engine can also be switched off while running by turning the starting key (1) directly to position "0".</p> <p><i>Note:</i> The engine continues running for several seconds after it is switched off. Before performing any further activities, wait until all moving components have come to a complete standstill.</p>
2	Remove the starting key.

## 7.5 Check the oil level

### Safety notes

 <b>CAUTION</b>	
 	<p><b>Danger of burns.</b></p> <p>There is a danger of burns when working on a hot engine.</p> <ul style="list-style-type: none"> <li>Wear safety gloves.</li> </ul>
<b>CAUTION</b>	
	<p><b>Danger of later engine damage.</b></p> <ul style="list-style-type: none"> <li>Operating the engine with an oil level below the <b>min.</b> mark or above the <b>max.</b> mark can lead to engine damage.</li> <li>When checking the oil level, the engine must be horizontal and have been switched off for a few minutes.</li> </ul>

## Overview

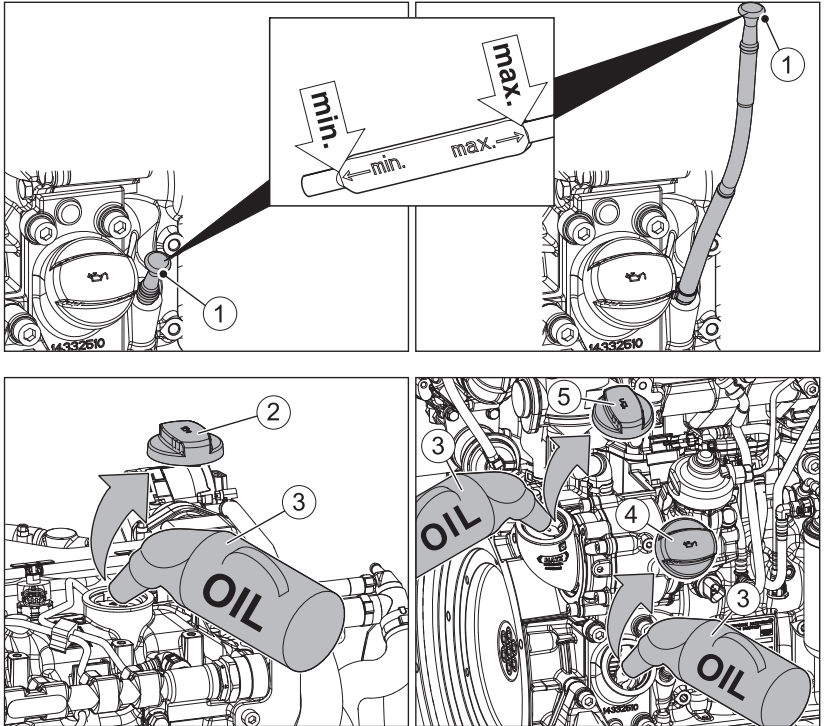

1	Dipstick (depending on the model)
2	Oil filler plug, top (option)
3	Oil refilling container
4	Oil filler plug, bottom
5	Oil filler plug, middle (option)

## Procedure — Checking oil level/adding oil









Step	Activity
1	Switch off the engine and wait several minutes for the engine oil to collect in the crankcase. The engine must be level.
2	Remove contamination on the engine in area of the dipstick (1) and the oil filler plug.
3	Pull out the dipstick and wipe it off with a clean towel.
4	Reinsert the dipstick.
5	Pull out the dipstick and check the oil level.

Step	Activity
6	If the oil level is close to the <b>min.</b> mark, add engine oil to the <b>max.</b> mark. For the specification and viscosity, see chapter 4.3 <i>Engine oil</i> , page 27.
7	Reinsert the dipstick.

## 7.6 Refueling

This diesel engine is intended for installation in a machine or for assembly with other machines to form a machine and does not have its own fuel tank. Follow the instructions from the manufacturer and comply with the following safety information.

### Safety notes

 <b>DANGER</b>	
 	<p><b>Fire hazard from fuel.</b></p> <p>Leaked or spilled fuel can ignite on hot engine parts and cause serious burn injuries.</p> <ul style="list-style-type: none"> <li>▪ Only refuel when the engine is switched off and has cooled down.</li> <li>▪ Never refuel in the vicinity of open flames or sparks that can cause ignition.</li> <li>▪ Do not smoke.</li> <li>▪ Do not spill fuel.</li> </ul>
 <b>CAUTION</b>	
	<p><b>Danger of environmental damage from spilled fuel.</b></p> <p>Do not overfill the fuel tank and do not spill fuel.</p> <ul style="list-style-type: none"> <li>▪ Collect any leaking fuel and dispose of it according to local environmental regulations.</li> </ul>
 <b>CAUTION</b>	
 	<p><b>Danger of injury.</b></p> <p>Repeated contact with diesel fuel can cause chapped and cracked skin.</p> <ul style="list-style-type: none"> <li>▪ Wear safety gloves.</li> <li>▪ If there is contact with the skin, thoroughly wash the affected areas of the skin with soap and water.</li> </ul>

**CAUTION****Engine damage from using low quality fuel.**

The use of fuel that does not meet the specifications can lead to engine damage.

- Only use the fuel specified in chapter 4.5 *Fuel, page 32*.
- The use of fuels that do not meet specifications require approval by Motorenfabrik HATZ (main plant).

**NOTICE**

Never run the tank empty if possible, as otherwise air can enter the fuel system. This can lead to damage to the injection system.

If the tank runs dry nevertheless, the fuel system must be drained prior to the next start (see chapter 6.6 *Venting the fuel system, page 61*).

**NOTICE**

For engines that are used for continuous operation or that are equipped with an automatic start/stop function, the engine must be switched off when refueling at the latest. At that time, the engine control unit must be switched off for at least 30 seconds (ignition off, main switch of the machine off or the battery main switch off). The reason for this is that, when the engine control unit is restarted, the cabling from the engine control unit to the water in fuel sensor is checked for electrical continuity. If the cabling is interrupted or the plug on the water in fuel sensor is detached, the engine control unit outputs an error message. The cable is not checked during operation. Thus, if a fault occurs on the cable during operation or the plug is detached from the water in fuel sensor, the water in fuel sensor will not be functional. The engine control unit will only detect the fault when it is restarted.

## 7.7 Regenerating the diesel particulate filter

This section contains the following subsections:

- **Automatic regeneration**
- **Starting manual regeneration**
- **Blocking regeneration**

### Introduction

The **TICD** engine model is equipped with a diesel particulate filter (DPF).

The diesel particulate filter filters soot particles out of the exhaust gas. During regular regeneration the accumulated soot particles are burnt off at high temperatures.

The following modes are made available by the engine control unit:

- **Automatic regeneration**, which starts automatically and runs through its routine without interruption. This mode is applied if the corresponding conditions are fulfilled (see *Automatic regeneration* section).
- **Manual regeneration**, which is started by the operator. During manual regeneration, the machine cannot be used.

### NOTICE



If the current situation prohibits regeneration, regeneration can be blocked (see section *Blocking regeneration*). However, the block should be deactivated as soon as possible to prevent damage to the diesel particulate filter.

### Safety notes



### DANGER



#### Danger of fire from hot exhaust gas system.

If inflammable materials come into contact with the exhaust gas flow or the hot exhaust gas system, these materials can ignite.

- Keep inflammable materials away from the exhaust gas system.
- Do not operate the engine (exhaust flow or hot exhaust gas system) in the direct vicinity of combustible materials.



### WARNING



#### Danger of injury from hot engine exhaust gases.

During the regeneration of the diesel particulate filter, the exhaust gas flow and the exhaust gas system reach a temperature of approx. 650 °C, which can lead to serious burn injuries.

- Ensure that nobody is endangered by the hot exhaust gases or the hot exhaust gas system.

### CAUTION

#### Danger of damaging the diesel particulate filter.

If the regeneration of the diesel particulate filter is blocked over a longer period, a large amount of particles collects in the filter. This can mean that neither automatic nor manual regeneration can be started. In these cases, a service regeneration is required by HATZ Service. In addition, there is a danger that the diesel particulate filter will be damaged or destroyed.





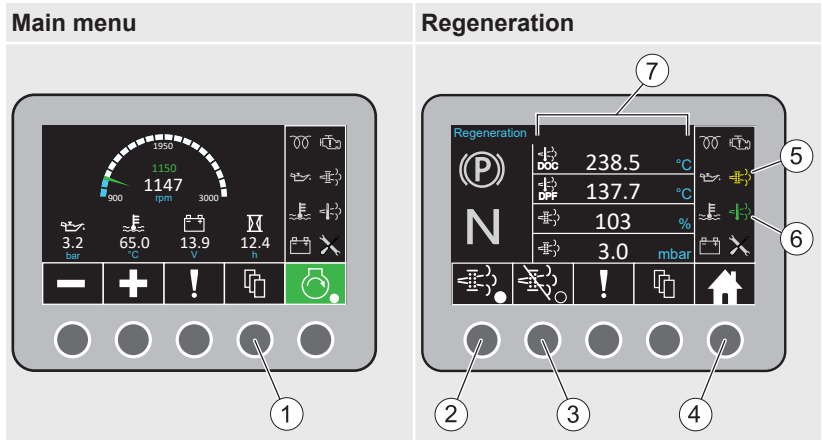

- Only block regeneration when needed, and unblock it again as soon as possible.

## Overview



1	Menu selection key
2	Start/stop manual regeneration
3	Activate/deactivate regeneration disable
4	Home (back to main menu)
5	<p>Symbol "Regeneration of diesel particulate filter required"</p> <ul style="list-style-type: none"> <li>▪ <b>Yellow</b> Automatic or manual regeneration required.</li> <li>▪ <b>Orange</b> Start automatic or manual regeneration <b>immediately</b>. The soot concentration in the particle filter has already reached an increased value.</li> </ul>
6	<p>Symbol "Regeneration of the diesel particulate filter has started"</p> <ul style="list-style-type: none"> <li>▪ <b>Green</b> Regeneration of the diesel particulate filter has started.</li> <li>▪ <b>Red</b> Warning of very hot engine exhaust gases. This indicator warns against injuries and the danger of fire due to very high temperatures (approx. 650 °C) during regeneration.</li> </ul>
7	<p>Indicator for:</p> <ul style="list-style-type: none"> <li>▪ Temperature in the diesel oxidation catalyst (DOC)</li> <li>▪ Temperature in the diesel particulate filter (DPF)</li> <li>▪ Load status of the diesel particulate filter</li> <li>▪ Differential pressure between DOC and DPF</li> </ul>

## Explanation of symbols

Symbol	Meaning
	<b>Neutral position</b> Lights up if the neutral position on the device is left during manual regeneration. Manual regeneration is stopped.
	<b>Parking brake</b> Lights up if the parking brake is released during manual regeneration. Manual regeneration is stopped.
	<b>Manual regeneration OFF</b>
	<b>Manual regeneration ON</b> The solid white circle shows that manual regeneration was started.
	<b>Regeneration disable OFF</b>
	<b>Regeneration disable ON</b> The solid white circle indicates that the regeneration disable was activated.

## Automatic regeneration

When indicator (5) **lights up**, this indicates that automatic regeneration of the diesel particulate filter is due. If indicator (6) lights up in addition, automatic regeneration has started. Automatic regeneration only starts under the following conditions:

- The regeneration disable is switched off (see section *Disabling regeneration*).
- The coolant temperature is over 10 °C
- Moderate to high engine utilization

When the above conditions are no longer fulfilled, regeneration is stopped. When the above conditions are fulfilled again, regeneration is resumed.

Regeneration is finished when indicators (5) and (6) have gone out.



**NOTICE**

If automatic regeneration is interrupted several times or does not start within 30 minutes or if the indicator (6) does not light up, it is recommended that you start manual regeneration in order to prevent damage to the particulate filter due to impermissibly high soot concentration.

If the indicator (5) lights up **orange**, this indicates that the soot concentration in the particulate filter is already at a raised value. Regeneration should be started immediately. This can be done automatically or manually.

**Starting manual regeneration**

Step	Activity
1	Secure the machine against rolling away or slipping.
2	Depending on the machine, engage the parking brake (if present) and set the transmission or the machine to neutral or activate the safety switch. If one of the above criteria is unfulfilled, the regeneration cannot be started. See also instructions in the documentation for the complete machine.
3	Press the button for the menu selection (1) 2x. The display changes to the <b>Regeneration</b> menu.
4	The regeneration disable (3) must be switched off (see section <i>Explanation of symbols</i> ).
5	Let the engine run and adjust it to a low engine speed.
6	<p>Starting manual regeneration</p> <ul style="list-style-type: none"> <li>▪ Press key (2). The indicator above it changes to the "Manual regeneration ON" symbol (see section <i>Explanation of symbols</i>). Indicators (5 and 6) light up; the regeneration process is started and takes approx. 15 to 30 minutes.</li> </ul> <p><i>Note:</i> During manual regeneration</p> <ul style="list-style-type: none"> <li>▪ The engine speed changes.</li> <li>▪ The engine noise may change.</li> <li>▪ Higher engine vibrations may occur than during normal operation.</li> </ul>
7	After regeneration is finished (indicators 5 and 6 go out), the machine can be used again.

**NOTICE**

To ensure uninterrupted manual regeneration, note the following:

- Do not change the engine speed.
- Leave the device in the idle setting.
- Do not disengage the parking brake (if available).
- Do not use the device during manual regeneration.

Failure to observe these steps will lead to the premature cancellation of regeneration.

**NOTICE**

Only start manual regeneration when the indicator (5) is lit. Starting regeneration without being prompted to do so by the indicator (5) results in premature wear of the diesel particulate filter.



**Disabling regeneration**

Step	Activity
1	<p>Press button (3) while the engine is running. The indicator above it changes to the "Regeneration disable ON" symbol, see section "Explanation of symbols", and indicator (5) has a line through it. Regeneration is disabled. In this case, automatic and manual regeneration will not be able to start and an active regeneration is stopped. Pressing the button again enables regeneration again and the indicator above it changes to the "Regeneration disable OFF" symbol.</p> <p><i>Note:</i> Switching off the engine also deactivates an activated regeneration block.</p>

## 8 Maintenance

### 8.1 General maintenance instructions

#### Safety notes

 <b>WARNING</b>	
	<p><b>Danger of injury from failure to follow the Operating Instructions and from performing unauthorized tasks on the machine.</b></p> <ul style="list-style-type: none"> <li>▪ Follow all instructions.</li> <li>▪ Do not perform activities for which no qualification is available. Contact properly trained personnel if necessary.</li> </ul>

<b>NOTICE</b>	
	<p><b>Comply with the safety chapter!</b></p> <p>Follow the basic safety instructions in chapter 3 <i>Safety</i>, page 7.</p>

- Maintenance tasks may only be performed by trained personnel.
- Accident prevention measures must be in accordance with the local accident prevention regulations.
- Perform setting and maintenance work at the specified intervals.
- Replace defective machine parts as soon as possible.
- Always wear personal protection equipment.
- Only use fully functional tools.
- Installation of unsuitable spare parts can lead to problems. We cannot accept liability for direct damage or secondary damage that results from this. We therefore recommend the use of **Hatz original spare parts**.
- Closely adhere to the maintenance conditions prescribed in this manual.
- Only make changes to the machine in agreement with the manufacturer.
- Only perform maintenance work when the engine is switched off.
- Protect the starting key from unauthorized access.
- Disconnect the negative battery terminal before carrying out maintenance work.
- Adhere to legal regulations when handling and disposing of used oil, filters, coolants, and cleaning agents.
- After completing maintenance work, check that all tools, screws, aids, and other objects are removed from the machine, and that all safety equipment has been replaced.

- Before starting, ensure that no persons are located in the danger zone of the engine or machine.



### Performance of maintenance work

The entire machine is designed to be maintenance friendly. Parts that require maintenance are easily accessible.

- Perform maintenance work faithfully at the specified intervals to prevent premature wear of the machine.
- Follow the notice and warning labels on the machine.
- Always retighten screw connections loosened during maintenance work.
- After the necessary maintenance and repair work is completed, perform a function test (test run).
- For maintenance work that is not listed and described in the maintenance documentation, please contact your nearest **HATZ service station**.

## 8.2 Maintenance work

### Safety note

 <b>CAUTION</b>	
	<p><b>Danger of injury from ignoring the maintenance instructions.</b></p> <ul style="list-style-type: none"> <li>▪ Only perform maintenance work when the engine is switched off.</li> <li>▪ Protect the starting key from unauthorized access.</li> <li>▪ Disconnect the negative battery terminal.</li> <li>▪ When the maintenance work has been completed, ensure that all tools are removed from the machine.</li> </ul>

### 8.2.1 Maintenance plan

<b>NOTICE</b>	
	<p>The maintenance intervals listed below apply to standard applications. If the operating conditions differ significantly from the usual use cases, it is possible that Hatz and the manufacturer of the complete machine reached a special agreement stipulating shorter or longer maintenance intervals. Corresponding information regarding different maintenance intervals can be found in the documentation of the complete machine.</p>

**Daily checks**

Symbol	Interval	Activity/check	Section
	Every 8–15 operating hours or every day before starting	Check the oil level	<i>7.5 Check the oil level, page 70</i>
		Check the intake area of the combustion air	<i>8.2.3 Check the intake area of the combustion air, page 87</i>
		Check the cooler fins for contamination	<i>8.2.4 Check the cooler fins for contamination, page 89</i>
		Check the cooling system	<i>8.2.5 Check the cooling system, page 90</i>

**Initial service of new or rebuilt engines**

Symbol	Service interval	Service step/check	Section
	After the first 50 operating hours we recommend:	Change the engine oil and oil filter <sup>2)</sup>	<i>8.2.6 Changing the engine oil and oil filter, page 93</i>
		Check the screw connections	<i>8.2.11 Check the screw connections, page 112</i>

## Routine service

Symbol	Service interval	Service step/check	Section
500h	Every 500 operating hours or every 12 months	Diagnosis of engine management <sup>1) 2)</sup> (to be performed by trained technicians)	
		Update of the engine control unit <sup>2) 3)</sup> (to be performed by trained personnel)	
		Clean the engine <sup>2)</sup>	8.2.7 <i>Clean the radiator fins, page 99</i>
		Check the anti-freeze concentration of the coolant <sup>2)</sup>	8.2.5 <i>Check the cooling system, page 90</i>
		Change the engine oil and oil filter <sup>2)</sup>	8.2.6 <i>Changing the engine oil and oil filter, page 93</i>
		Check the poly v belt <sup>2)</sup>	8.2.8 <i>Checking the poly v belt, page 102</i>
		Change the oil separator of the crankcase ventilation <sup>2)</sup>	8.2.10 <i>Change the oil separator of the crankcase ventilation, page 111</i>
		Check the screw connections <sup>2)</sup>	8.2.11 <i>Check the screw connections, page 112</i>
		Change the fuel prefilter <sup>2)</sup>	8.2.13 <i>Changing the fuel prefilter, page 114</i>
		Change the main fuel filter <sup>2)</sup>	8.2.14 <i>Changing the main fuel filter, page 116</i>
		Drain the charge air cooler <sup>2) 5)</sup>	8.2.17 <i>Draining the charge air cooler, page 124</i>
Every 500 operating hours or when indicated, at least every 12 months	Change the air filter cartridge (primary filter) <sup>4)</sup>	8.2.15 <i>Servicing the air filter (optional), page 119</i>	

Symbol	Service interval	Service step/check	Section
	When indicated, at least every 12 months	Drain the water separator <sup>2)</sup>	<i>8.2.12 Drain the water separator, page 112</i>
	Every 4 years	Change the coolant	<i>8.2.16 Change the coolant, page 121</i>
	If necessary, but every 3,000 operating hours at the latest	Replace the poly v belts	<i>8.2.9 Replacing the poly v belts, page 106</i>
	Every 4,000 operating hours	Clean the main radiator of the exhaust gas recirculation (EGR) <sup>6)</sup> (to be performed by trained technicians)	
		Clean the diesel particulate filter (DPF) <sup>7)</sup> (to be performed by trained technicians)	

<sup>1)</sup> The engine control module continuously evaluates the engine-relevant data during operation. If an engine malfunction or deviations from the setpoints occur, these data are written to the error memory. Stored data can be read out and evaluated for fault diagnostics by a Hatz service partner using the Hatz Diagnostic Software HDS<sup>2)</sup>. In this way, faults can be detected and eliminated early on or preventative maintenance can be performed.

<sup>2)</sup> Service according to the service interval or after 12 months, whichever comes first.

<sup>3)</sup> The engine control unit can only be updated using the Hatz diagnostic software HDS<sup>2)</sup>. The update installs extensions and improvements of the control software.

<sup>4)</sup> The secondary filter must be replaced after every fifth replacement of the primary filter, though no later than every two years.

<sup>5)</sup> Engine specifications TI, TIC and TICD.

<sup>6)</sup> Engine specification TIC and TICD.

<sup>7)</sup> To overhaul the diesel particulate filter, Hatz offers cleaning program **EasyClean**.

For more information, see [www.hatz.com/easyclean](http://www.hatz.com/easyclean)

## 8.2.2 Additional work on the Silent Pack

### Safety notes



#### WARNING



#### Danger of injury from rotating parts.

Touching the fans or poly v belts can lead to serious injury when the engine is running.

- Only operate the engine when all covers are installed.



#### CAUTION



#### Danger of burns.

There is a danger of burns when working on a hot engine.

- Let the engine cool.
- Wear safety gloves.



### Overview

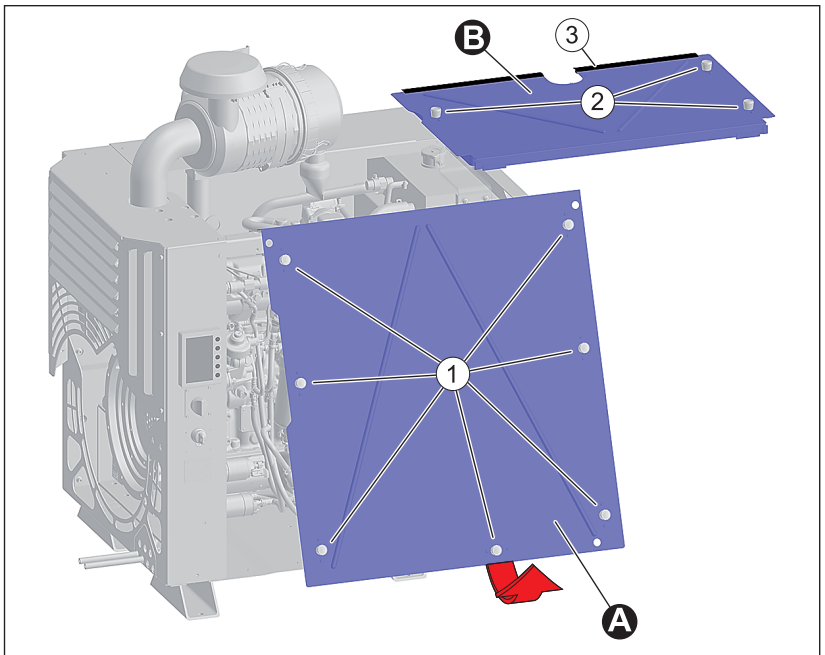



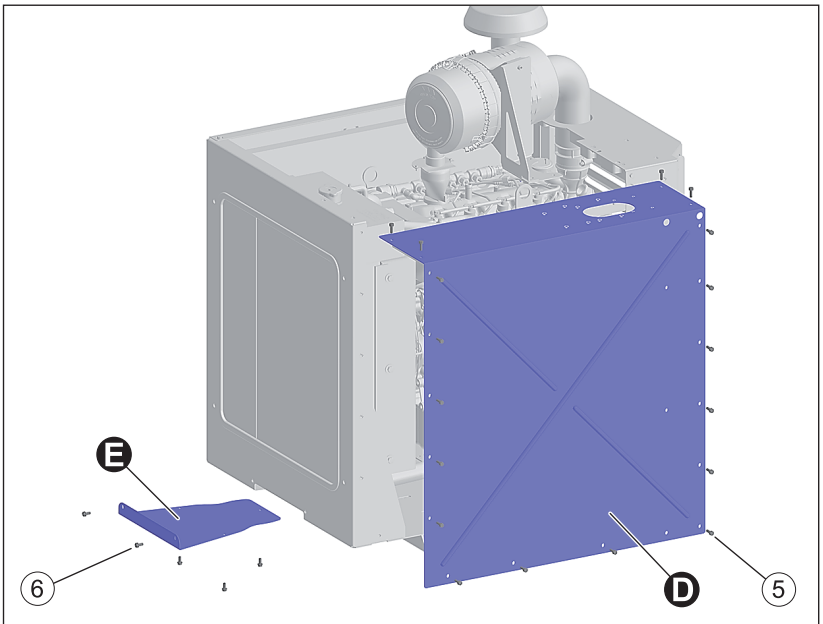
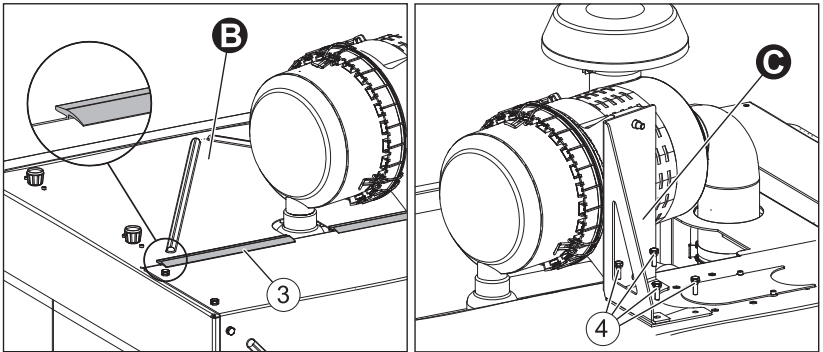

<b>A</b>	Control side maintenance cover
<b>B</b>	Top maintenance cover
<b>C</b>	Air filter bracket
<b>D</b>	Side cover on exhaust gas side
<b>E</b>	Access cover to the drain plug on the radiator
<b>1</b>	Clamp-type fasteners for control side maintenance cover
<b>2</b>	Clamp-type fasteners for top maintenance cover
<b>3</b>	Sealing lip

4	Fixing screws for bracket for the air filter (4 pieces)
5	Fixing screws for side cover exhaust side (18)
6	Fixing screws for access lid (5 pieces)

### Access to the service points

With the Silent Pack, the engine is surrounded by a noise and weather protection capsule. In order to access the respective service points, the components listed in the following must be disassembled beforehand:

Service step	Component disassembly
Check the oil level	A
Check the intake area of the combustion air	A, B
Check the cooling system	A, B, C, D
Change the engine oil and oil filter	A
Changing the fuel prefilter	A
Changing the main fuel filter	A
Check or replace the poly v belts	A, B, C, D
Change the oil separator of the crankcase ventilation	A, B
Check the screw connections	A, B, C, D
Clean the engine	A, B, C, D
Change the coolant	A, B, E





### Procedure

Step	Activity
<b>Remove the control side maintenance cover (A)</b>	
1	Turn clamp-type fasteners (1) to the left up to the stop. Tip maintenance cover on the bottom to the outside and lift away upwards.
<b>Remove the top maintenance cover (B)</b>	
1	Remove the control side maintenance cover (A)
2	Turn clamp-type fasteners (2) to the left up to the stop and then remove the maintenance cover.
<b>Remove the air filter fastening (C)</b>	
1	Unscrew the fixing screws (4).

Step	Activity
<b>Remove the side panel on the exhaust gas side (D)</b>	
1	Remove the top maintenance cover (B)
2	Remove the air filter fastening (C).
3	Unscrew the fixing screws (5).
4	Remove the side trim panel (D).
<b>Remove the access cover (E) to the drain plug on the radiator</b>	
1	Unscrew the fixing screws (6).
2	Remove the access cover (E).
<b>Assembly</b>	
1	Mount all parts again after the maintenance steps have been completed. Make sure that the seal lip (3) of the maintenance cover (B) is not trapped!

### 8.2.3 Check the intake area of the combustion air

#### Safety notes

 <b>CAUTION</b>	
 	<p><b>Danger of burns.</b></p> <p>There is a danger of burns when working on a hot engine.</p> <ul style="list-style-type: none"> <li>▪ Let the engine cool.</li> <li>▪ Wear safety gloves.</li> </ul>
<b>NOTICE</b>	
	<p>In case of heavy contamination, shorten the maintenance intervals accordingly (see chapter 8.2.1 <i>Maintenance plan</i>, page 80).</p>

## Overview (HATZ air filter)

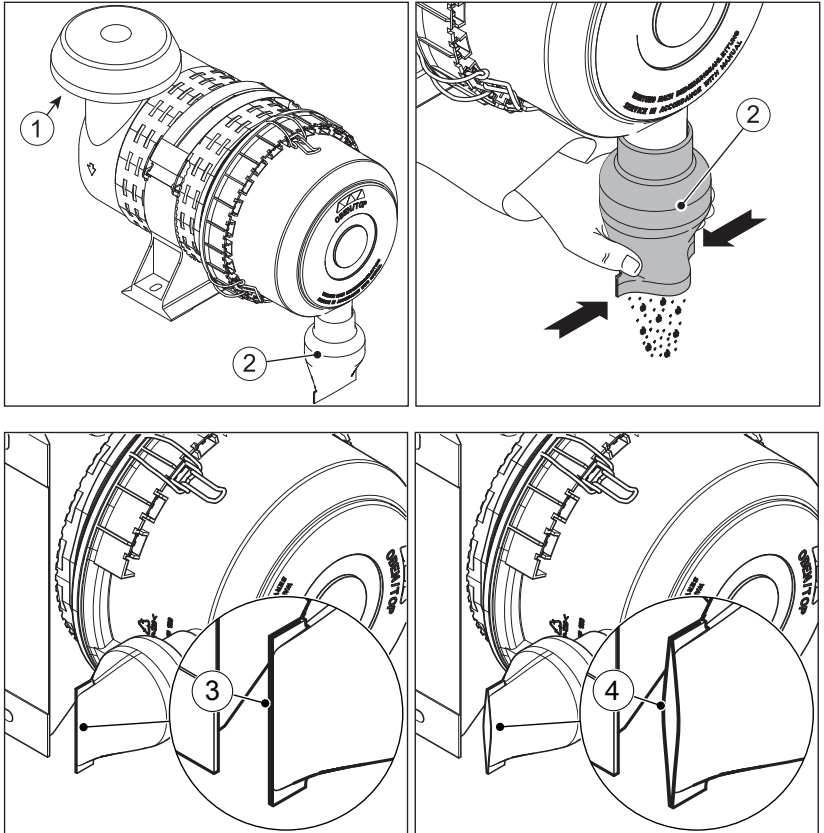

1	Intake opening for combustion air
2	Dust discharge valve
3	Rubber lips OK
4	Rubber lips deformed







## Procedure

Step	Activity
1	Check the intake opening (1) for coarse contamination such as leaves, heavy dust deposits etc., and clean if necessary.
2	Check that the dust discharge valve (2) is clear. Remove dust seals by pressing them together.

Step	Activity
3	Make sure that the rubber lips (3) run parallel to each other. The gap between the rubber lips must be a maximum of 2 mm. Deformed rubber lips (4) impair the function of the precleaner, thus shortening the maintenance interval of the air filter. Replace the dust discharge valve if required.

## 8.2.4 Check the cooler fins for contamination

### Safety notes

 <b>CAUTION</b>	
 	<p><b>Danger of burns.</b></p> <p>There is a danger of burns when working on a hot engine.</p> <ul style="list-style-type: none"> <li>▪ Let the engine cool.</li> <li>▪ Wear safety gloves.</li> </ul>
 <b>CAUTION</b>	
 	<p><b>Danger of injury.</b></p> <p>When working with compressed air, foreign bodies may fly into your eyes.</p> <ul style="list-style-type: none"> <li>▪ Wear safety goggles.</li> <li>▪ Never direct the compressed air jet toward people or toward yourself.</li> </ul>
<b>CAUTION</b>	
	<p><b>Danger of engine damage from overheating.</b></p> <p>The engine temperature indicator lights up as soon as the engine becomes inadmissibly hot.</p> <ul style="list-style-type: none"> <li>▪ Switch off the engine and eliminate the cause.</li> </ul>
<b>NOTICE</b>	
	<p>In case of heavy contamination, shorten the maintenance intervals accordingly (see chapter 8.2.1 <i>Maintenance plan, page 80</i>).</p>

## Overview

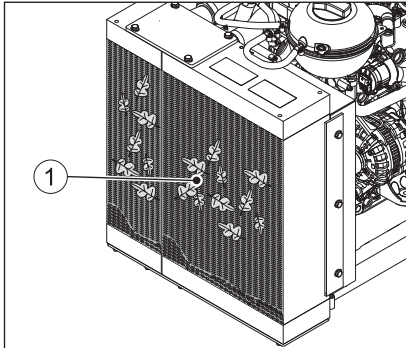





1	Cooler fins
---	-------------

## Procedure

Step	Activity
1	Check the cooler fins (1) for coarse contamination such as leaves, heavy dust deposits etc., and clean if necessary (see chapter 8.2.7 <i>Clean the radiator fins, page 99</i> ).

## 8.2.5 Check the cooling system

### Safety notes

 <b>CAUTION</b>	
 	<p><b>Danger of scalding and risk of environmental damage due to hot coolant.</b></p> <ul style="list-style-type: none"> <li>▪ Excessive coolant is blown off from the sealing cap on the expansion tank. After topping up the cooling system never move parts of your body or face close to the sealing cap.</li> <li>▪ Never top up coolant above the MAX - mark on the expansion tank.</li> <li>▪ Never stop escaping coolant with your bare hands.</li> </ul>
 <b>CAUTION</b>	
	<p><b>Danger of burns.</b></p> <p>There is a danger of burns when working on a hot engine.</p> <ul style="list-style-type: none"> <li>▪ Let the engine cool before maintenance.</li> </ul>

**CAUTION****Danger of burns.**

There is a danger of burns when working on a hot cooling system. The cooling system is pressurized when the engine is hot.



- Let the engine cool.
- Wear safety gloves.

**CAUTION****Danger of later engine damage.**

- Operating the engine with a coolant level below the **MIN.** mark can lead to engine damage.
- When checking the coolant level, the engine must be horizontal and switched off.

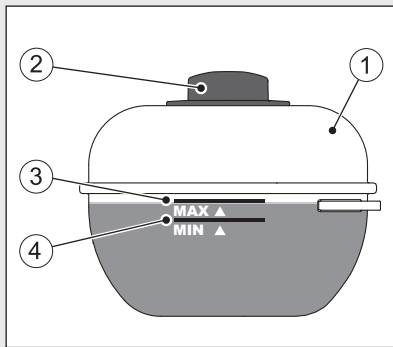
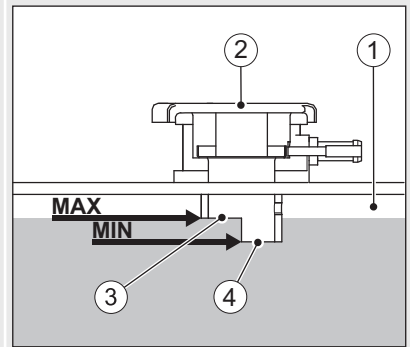
**Overview****External expansion tank****Integrated expansion tank**

1	Expansion tank for coolant
2	Sealing cap
3	<b>MAX</b> - Maximum coolant level
4	<b>MIN</b> - Minimum coolant level

**Procedure for checking the coolant level**

Step	Activity
1	The coolant must be between the <b>MIN</b> and <b>MAX</b> marks on a switched-off and cooled-down engine. For a warm engine, the level can also be slightly above the <b>MAX</b> mark.

## Procedure for topping up coolant

Step	Activity
1	Carefully open the sealing cap (2).
2	Top up prepared coolant to the <b>MAX</b> mark on the expansion tank. For the preparation of the coolant, see section 4.4 <i>Coolant</i> , page 28.
3	Tighten the sealing cap (2) all the way by hand.

### NOTICE



Since the corrosion and antifreeze concentration decreases over time, carry out a check with a commercially available antifreeze tester as per the maintenance schedule.

If the concentration is too low, either:

- drain part of the coolant and bring to the required frost safety level by adding cooler protective fluid, or
- replace the entire filling of coolant (see section 8.2.16 *Change the coolant*, page 121).

## Checking the cooling system for leaks

Coolants losses are mostly caused by leaks in the cooling system.

On a non-leaking cooling system, losses only occur when the coolant boils and this then causes coolant to be pressed out of the cooling system at the sealing cap on the expansion tank. The cause of this can be contamination in the area of the cooler fins (see chapter 8.2.4 *Check the cooler fins for contamination*, page 89).

## Overview

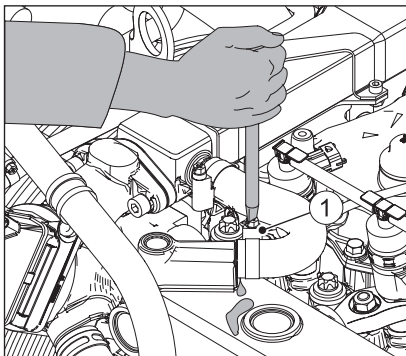

1	Hose clip
---	-----------



## Procedure









Step	Activity
1	Check the cooling system for leaks and rectify the cause immediately - in case of doubt consult <b>HATZ Service</b> for advice.
2	When hose connections are loose, retighten the hose clips (1).

### 8.2.6 Changing the engine oil and oil filter

This chapter contains the following subchapters:

- **Changing the oil filter**
- **Draining the engine oil**
- **Filling the engine oil**
- **Concluding the inspection work**

#### Safety notes

 <b>CAUTION</b>	
 	<p><b>Danger of burns.</b></p> <p>When working on the engine, there is a danger of burns from hot oil.</p> <ul style="list-style-type: none"> <li>▪ Wear personal protective equipment (gloves).</li> </ul>
 <b>CAUTION</b>	
	<p><b>Danger of environmental damage from spilled used oil.</b></p> <p>Used oil is water-polluting.</p> <ul style="list-style-type: none"> <li>▪ Do not allow them to enter the ground water, water bodies, or sewage system.</li> <li>▪ Collect the used oil and dispose of it according to local environmental regulations.</li> </ul>
 <b>CAUTION</b>	
 	<p><b>Danger of injury</b></p> <p>Prolonged contact with engine oil can lead to irritation of the skin.</p> <ul style="list-style-type: none"> <li>▪ Wear safety gloves.</li> <li>▪ If there is contact with the skin, thoroughly wash the affected areas of the skin with soap and water.</li> </ul>

**CAUTION****Danger of later engine damage.**

- Operating the engine with an oil level below the **min.** mark or above the **max.** mark can lead to engine damage.
- When checking the oil level, the engine must be horizontal and have been switched off for a few minutes.

**NOTICE**

- The engine must be level.
- The engine must be switched off.
- Only drain engine oil while it is warm.

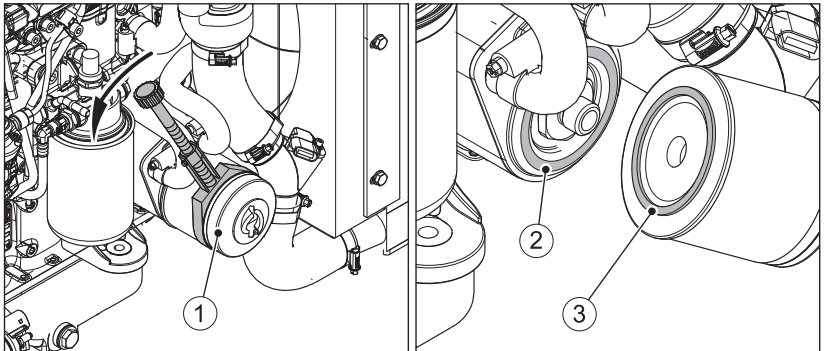
**Changing the oil filter****Overview – Horizontal attachment**

1	Oil filter
2	Sealing surface
3	Gasket

**Procedure**

Step	Activity
1	Keep a container ready for collecting the used oil.
2	Loosen the oil filter (1) with a strap wrench or similar and unscrew it.
3	Dispose of the old filter in accordance with local environmental regulations.
4	Thoroughly clean the sealing surface (2).

Step	Activity
5	Lightly oil the sealing lip (3) of the new oil filter.
6	Screw in the oil filter and <b>tighten it by hand</b> .

### Overview – Vertical attachment

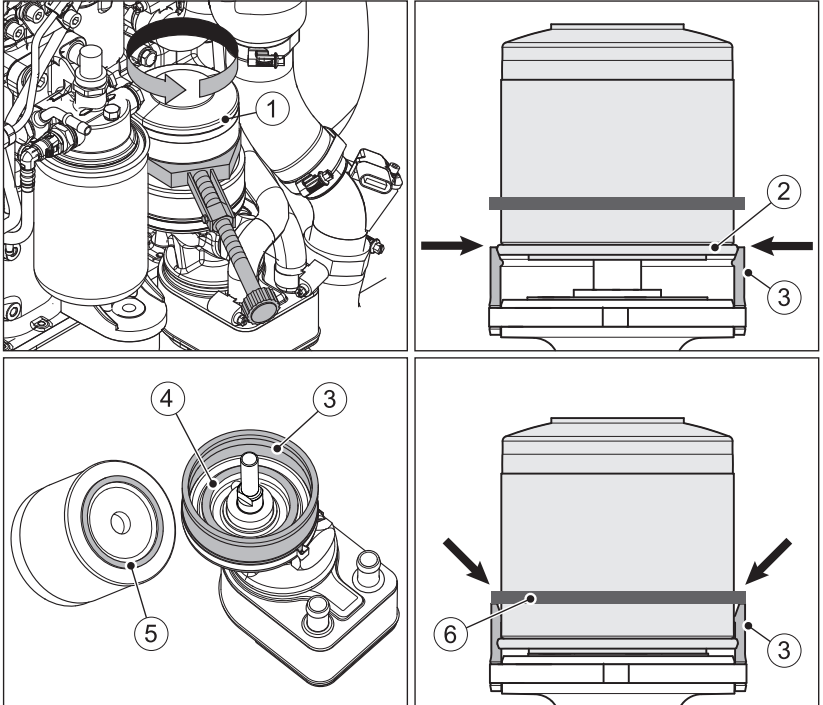

1	Oil filter
2	Collar on the oil filter
3	Shaped element
4	Sealing surface
5	Sealing ring
6	Guard ring

## Procedure

Step	Activity
1	Loosen the oil filter (1) with a strap wrench or similar and unscrew it until the collar (2) of the oil filter is at the same level as the shaped element (3). In this position, a valve releases the oil return into the crankcase which allows the oil filter to empty.
2	Fully unscrew the oil filter after a waiting period of approx. 30 seconds.
3	Dispose of the old filter in accordance with local environmental regulations.
4	Thoroughly clean the shaped element (3) and sealing surface (4).
5	Lightly oil the sealing lip (5) of the new oil filter.
6	Screw in the oil filter and <b>tighten it by hand</b> .
7	Make sure that the guard ring (6) seats fully on the shaped element (3). The guard ring prevents dirt from accumulating between the oil filter and shaped element.

## Draining the engine oil

### Overview – Model with oil drain screw

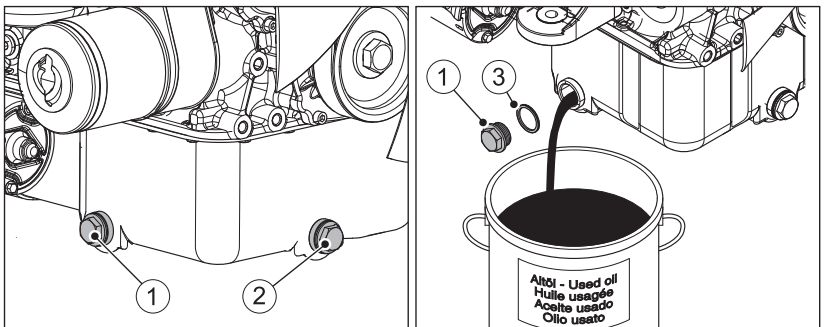

1	Oil drain screw (side)
2	Oil drain screw (front)
3	Gasket

**Procedure**

Step	Activity
1	Keep a container ready for collecting the used oil. The container must be large enough to hold the entire amount of engine oil. For the engine oil capacity, see chapter 4.1 <i>Engine information and filling quantities</i> , page 21.
2	Depending on oil sump version, the engine oil can be drained at oil drain screw (1) or (2). Unscrew the oil drain screw and drain the used oil entirely.
3	Screw in the cleaned oil drain screw with the new sealing ring and tighten. Tightening torque: 58 Nm.

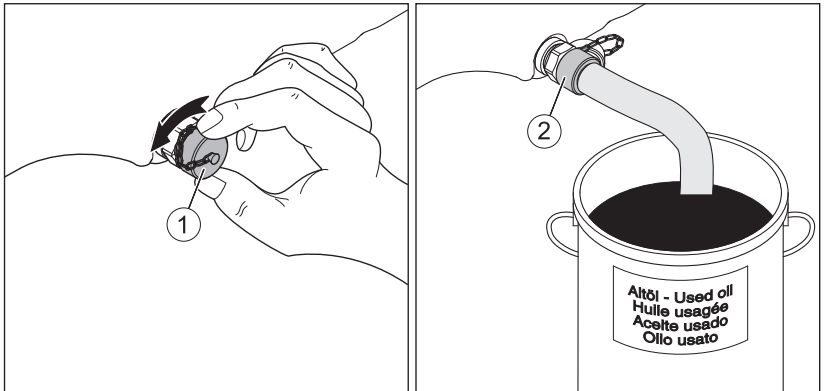
**Overview – Model with oil drain valve**

1	Screw plug for oil drain valve
2	Oil drain hose

**Procedure**

Step	Activity
1	Keep a container ready for collecting the used oil. The container must be large enough to hold the entire amount of engine oil. For the engine oil capacity, see chapter 4.1 <i>Engine information and filling quantities</i> , page 21.
2	Remove the screw plug (1).
3	Place the oil drain hose (2) on the drain valve and tighten by hand. <ul style="list-style-type: none"> <li>During tightening, the drain valve opens allowing the used oil to drain.</li> </ul>

Step	Activity
4	Remove the drain hose and reattach the screw plug.

## Filling the engine oil

### Overview

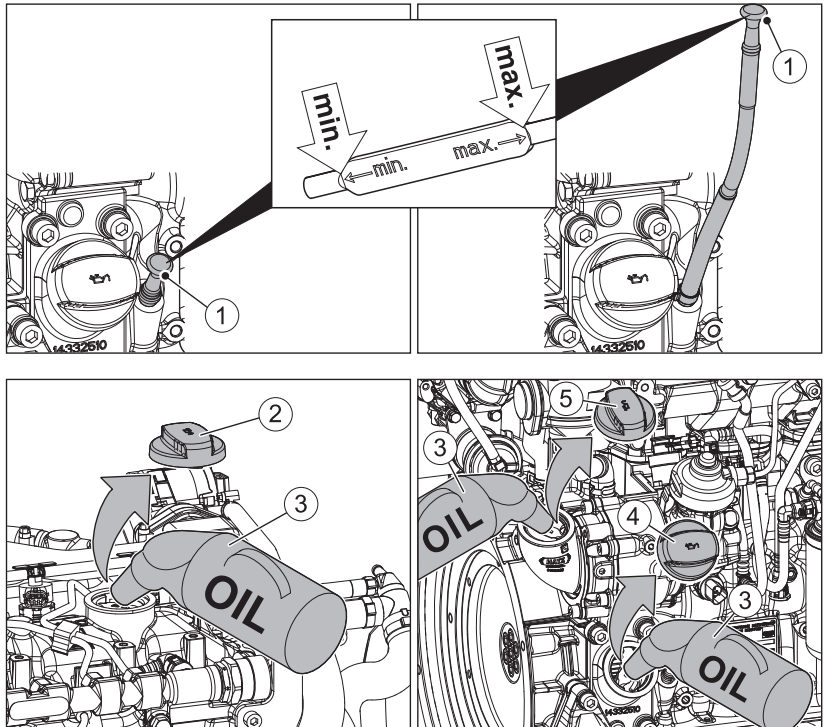

1	Dipstick (depending on the model)
2	Oil filler plug, top (option)
3	Oil refilling container
4	Oil filler plug, bottom
5	Oil filler plug, middle (option)

### Procedure

Step	Activity
1	Pull out the dipstick (1) and clean it.
2	Depending on the model, unscrew oil filler plug (2), (4) or (5).





Step	Activity
3	Fill with engine oil. For the specification and viscosity, see section 4.3 <i>Engine oil</i> , page 27. For the filling quantity, see section 4.1 <i>Engine information and filling quantities</i> , page 21.
4	Reinsert the dipstick.
5	Pull out the dipstick and check the oil level.
6	If required, add engine oil to the max. mark.
7	Reinsert the dipstick.
8	Screw in the oil filler plug.

### Concluding the inspection work

Step	Activity
1	Check the oil level after a short test run and correct if necessary.
2	Check the oil filter for tightness and retighten by hand if necessary.

## 8.2.7 Clean the radiator fins

### Safety notes

 <b>DANGER</b>	
	<p><b>Danger of explosion from flammable cleaning agents.</b></p> <p>Cleaning with benzene is an explosion hazard. It is highly flammable, can become electrostatically charged, and can generate an explosive gas/air mixture.</p> <ul style="list-style-type: none"> <li>▪ Use halogen-free, cold cleaners with a high flash point for cleaning.</li> <li>▪ Comply with manufacturer's instructions.</li> </ul>
 <b>CAUTION</b>	
	<p><b>Danger of environmental pollution due to oil and cleaning agents.</b></p> <p>Oil and cleaning agents are hazardous to the environment.</p> <ul style="list-style-type: none"> <li>▪ Do not allow them to enter the ground water, water bodies, or sewage system.</li> <li>▪ Only clean the machine at the washing area intended for this.</li> </ul>

**CAUTION****Danger of burns.**

There is a danger of burns when working on a hot engine.

- Let the engine cool.
- Wear safety gloves.

**CAUTION****Danger of injury.**

When working with compressed air, foreign bodies may fly into your eyes.

- Wear safety goggles.
- Never direct the compressed air jet toward people or toward yourself.

**CAUTION****Danger of damage to the machine from incorrect engine cleaning.**

- Let the engine fully cool down before cleaning.
- Do not use gasoline or acid-based cleaning agents.
- Do not spray electrical and electronic components with a water jet or high pressure jet during cleaning
- Never aim the water jet into the intake opening for combustion air or into the exhaust pipe.

**CAUTION****Damage to the cooler fins due to improper cleaning.**

- Never clean the cooler fins with a tool such as a spatula or screwdriver. A reduction in cooler performance through bent cooler fins or cooler leaks may be the result.

**NOTICE**

In case of heavy contamination, shorten the maintenance intervals accordingly (see chapter 8.2.1 *Maintenance plan*, page 80).



## Overview

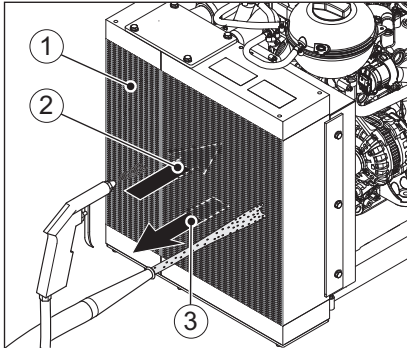

1	Cooler fins
2	Direction of flow of the cooling air with suction fan
3	Direction of flow of the cooling air with forced-draught fan

## Procedure

Step	Activity
<b>Cleaning in case of dry dirt contamination</b>	
1	Clean the radiator fins either with compressed air or flush with a water jet - depending on the amount of accumulated dirt. Work first against the direction of flow of the cooling air and then in the direction of flow.
<b>Cleaning wet or oily dirt contamination</b>	
1	Spray the entire area with a suitable cold cleaner according to the manufacturer's instructions and then clean off with a water jet. Work first against the direction of flow of the cooling air and then in the direction of flow.
2	Identify the cause of the oiling and seal the leak.
<b>After the cleaning</b>	
1	Let the engine run warm until it has completely dried to prevent rust formation.

## 8.2.8 Checking the poly v belt

This section contains the following subsections:

- **Checking the poly v belt for damage**
- **Checking and setting the belt tension**

### Safety notes



#### CAUTION



#### Danger of burns.

There is a danger of burns when working on a hot engine.

- Let the engine cool before maintenance.

### Preparation

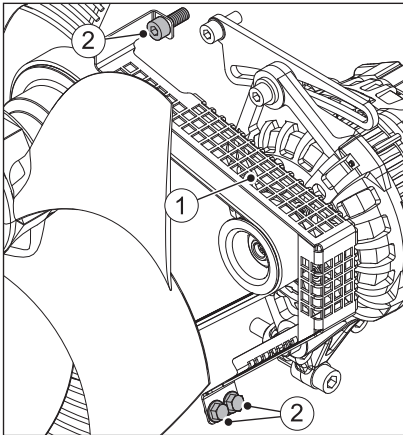

Step	Activity
1	Unscrew the optional belt guard (1). Unscrew the fixing screws (2) for this.

## Checking the poly v belt for damage

### Overview

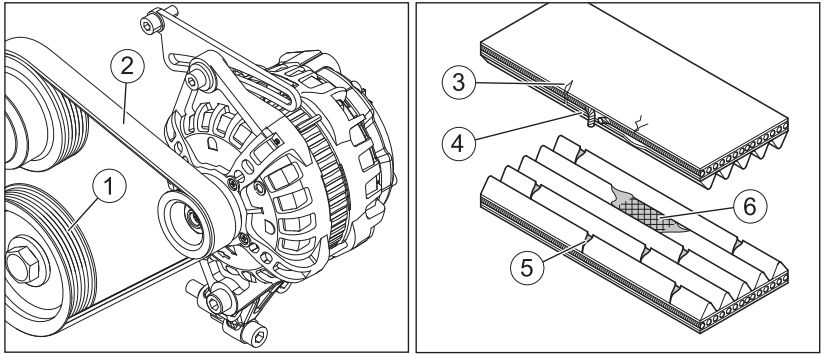

1	Pulley
2	Poly v belt

### Damage to the poly v belt

3	Transverse cracks on the rear
4	Fraying on the edges
5	Transverse cracks in multiple ribs
6	Broken ribs

### Procedure

Step	Activity
1	<p>Check the poly v belt (2) for the following damage:</p> <ul style="list-style-type: none"> <li>▪ Transverse cracks on the rear of the belt.</li> <li>▪ Fraying on the side.</li> <li>▪ Accumulation of dirt between the ribs.</li> <li>▪ Oily dirt contamination.</li> <li>▪ Transverse cracks in multiple ribs.</li> <li>▪ Broken ribs.</li> </ul> <p>If one or more of these instances of damage are present, replace the poly v belt immediately (see section 8.2.9 <i>Replacing the poly v belts</i>, page 106).</p>

## Checking and setting the belt tension

### Model without A/C compressor

The following description only applies to engines **without** A/C compressor. For the model **with** A/C compressor, a belt tensioner with spring preload always ensures the correct belt tension. The checking and setting of the belt tension is omitted here. For details, see section 8.2.9 *Replacing the poly v belts*, page 106, subsection *Belt run*.

#### NOTICE



- The cause of running noises of the poly v belt is mostly that the pretension on the belt is too low.
- Too low a belt pretension causes early wear of the poly v belt. Regularly check the belt tension, retension the poly v belt if required.

### Overview

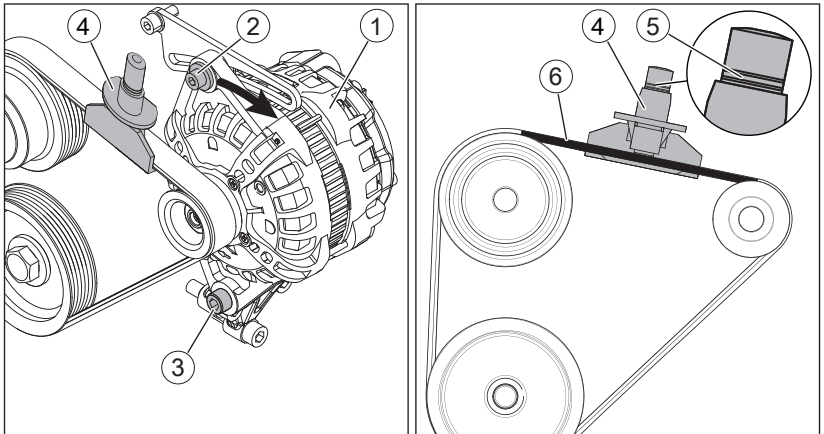

1	Alternator
2	Upper fixing screw on the generator
3	Lower fixing screw on the generator
4	"Facom DM.16" belt tension meter
5	Display on the belt tension meter
6	Measuring point for belt tension

### Setting values for the belt tension

The pretensioning force or the vibration frequency of the belt is decisive for adjustment of the belt tension. For this, we recommend the use of the DM.16 belt tension meter from Facom or a frequency meter. If neither of these meters are available, please contact your nearest **HATZ Service**.

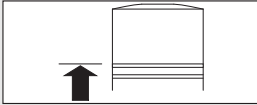
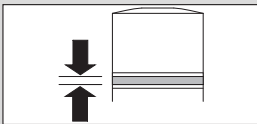
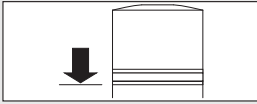
	Belt tension	
	Display (5) on the "Facom" belt tension meter	Vibration frequency (frequency meter)
<b>New belt</b>		210 Hz (+ 10 Hz)
<b>Belt after maintenance interval</b>		150 Hz (+ 10 Hz)
<b>Minimum tension</b>		125 Hz

### Procedure

Step	Activity
<b>Checking the belt tension</b>	
1	Check the belt tension at the measuring point (6) in accordance with the manual of the measuring device manufacturer and compare with the <i>setting values for the belt tension</i> . Adjust the belt tension if required.
<b>Setting the belt tension</b>	
1	Undo fixing screws (2) and (3).
2	Turn the generator (1) in the direction of the arrow, hold and - at the same time - tighten the fixing screws of the generator in this position.
3	Check the belt tension again.
4	If necessary, correct the belt tension.

### Final steps



Step	Activity
1	Mount the belt guard again.

## 8.2.9 Replacing the poly v belts

This section contains the following subsections:

- **Belt run**
- **Preparatory activities**
- **Engine without A/C compressor**
- **Engine with A/C compressor**

### Safety note

 <b>CAUTION</b>	
	<p><b>Danger of burns.</b></p> <p>There is a danger of burns when working on a hot engine.</p> <ul style="list-style-type: none"> <li>▪ Let the engine cool before maintenance.</li> </ul>

### Belt run

Engine without A/C compressor

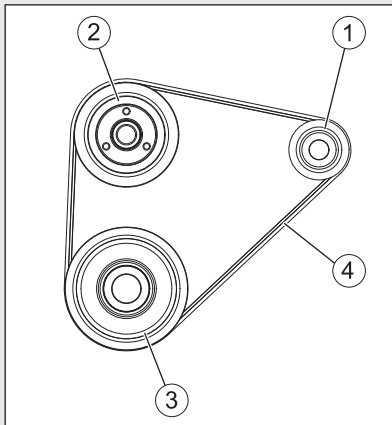

Engine with A/C compressor

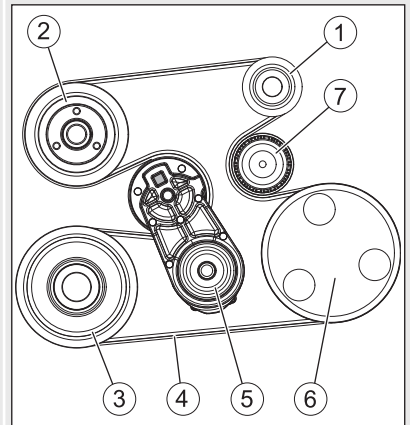

1	Alternator
2	Water pump
3	Crankshaft
4	Poly-V belt
5	Belt tensioner
6	A/C compressor
7	Pulley

## Preparatory activities

### Overview

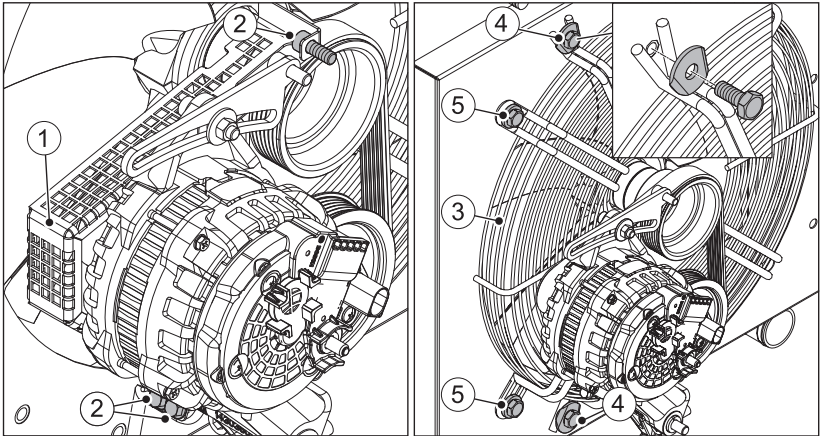

1	Belt guard
2	Fixing screws for the belt guard
3	Protective guard (left half)
4	Connecting screws, protective guard halves (top and bottom)
5	Fixing screws, protective guard (top and bottom)

### Procedure

Step	Activity
1	Unscrew the optional belt guard (1). Unscrew the fixing screws (2) for this.
2	Remove the left half of the optional protective guard (3) by unscrewing the screws (4) and (5) (at the top and bottom).

## Engine without A/C compressor

### Overview

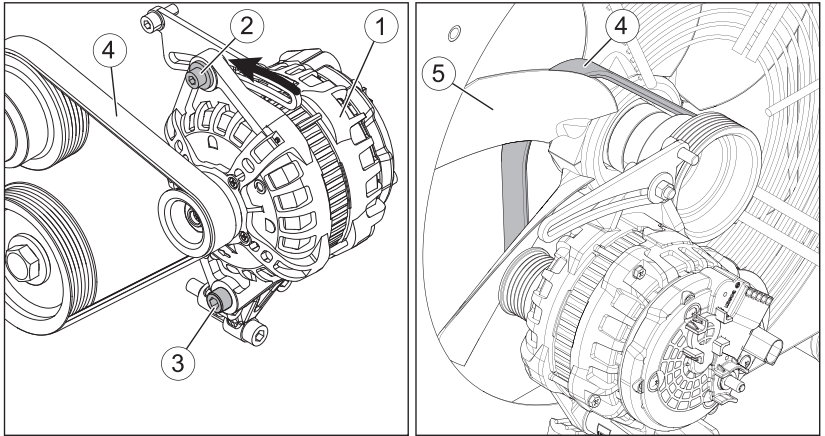

1	Alternator
2	Upper fixing screw on the generator
3	Lower fixing screw on the generator
4	Poly v belt
5	Fan blade

### Procedure

Step	Activity
1	Undo fixing screws (2) and (3).
2	Turn the generator (1) in the direction of the arrow to the stop.
3	Remove the loose poly v belt (4) from the pulley.
4	Carefully lift the poly v belt over a fan blade. Turn the fan further in the counterclockwise direction and lift the belt over the remaining fan blades until it is completely free.
5	Check the pulley for perfect condition. If the grooves are broken off or bent, renew the damaged pulley.
6	Feed a new poly v belt over the fan blade in the same way from the radiator side.
7	Lay the poly v belt over the pulley wheels and tighten (see section 8.2.8 <i>Checking the poly v belt</i> , page 104).



Step	Activity
8	Insert the connection and fixing screws for the protective guard. For the tightening torque, see section 4.1 <i>Engine information and filling quantities, page 21.</i>
9	Install the belt guard.

### Engine with A/C compressor

#### Safety note



#### CAUTION



#### Danger of injury.

The belt tensioner is under spring preload. When tensioning and relieving, there is a danger of injury due to crushing or jamming on preloaded parts.

- Carry out the work on the belt with particular caution.

#### Overview

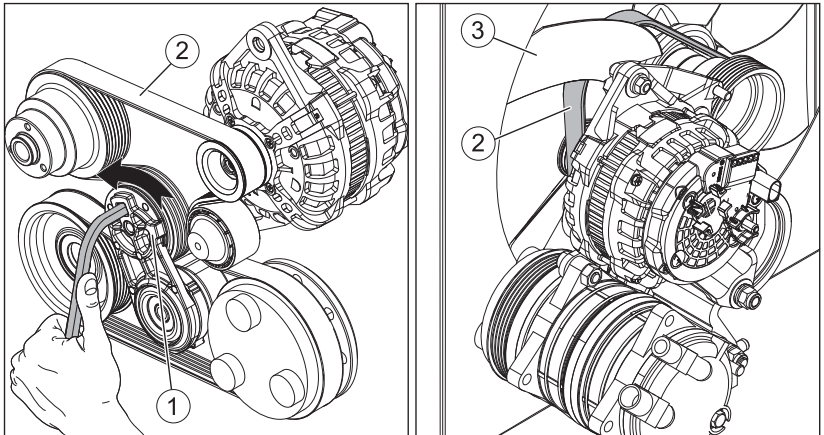



1	Belt tensioner
2	Poly v belt
3	Fan blade

**Procedure**

<b>Step</b>	<b>Activity</b>
1	Insert a 3/8" square key into the groove in the belt tensioner (1).
2	Turn the belt tensioner in the direction of the arrow, thus relieving the tension of the poly v belt (2).
3	Remove the loose poly v belt from the pulley.
4	Slowly relieve the belt tensioner.
5	Carefully lift the poly v belt over a fan blade. Turn the fan further in the counterclockwise direction and lift the belt over the remaining fan blades until it is completely free.
6	Check the pulley, belt tensioner and pulley for perfect condition. If the grooves are broken off or bent, renew the damaged pulley.
7	Feed a new poly v belt over the fan blade in the same way from the radiator side.
8	Place the poly v belts on all pulleys, except the belt tensioners. Monitor the belt run.
9	Turn the belt tensioner in the direction of the arrow and lay on the poly v belt.
10	Slowly relieve the belt tensioner.
11	Check that the poly v belt is correctly placed on the pulley.
12	Insert the connection and fixing screws for the protective guard. For the tightening torque, see section <i>4.1 Engine information and filling quantities, page 21</i> .
13	Install the belt guard.

## 8.2.10 Change the oil separator of the crankcase ventilation

### Safety note

 <b>CAUTION</b>	
	<p><b>Danger of burns.</b></p> <p>There is a danger of burns when working on a hot engine.</p> <ul style="list-style-type: none"> <li>Let the engine cool before maintenance.</li> </ul>

### Overview

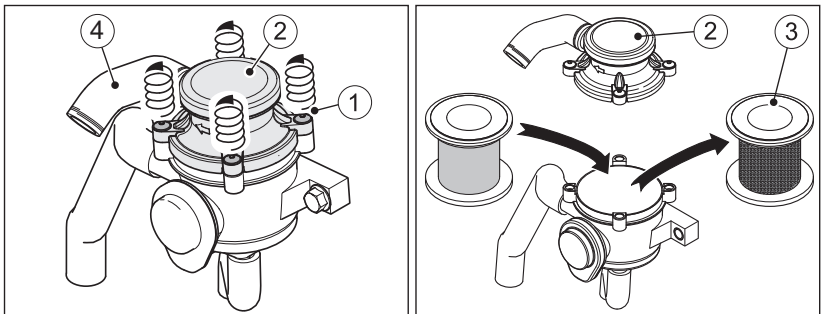

1	Mounting bolts (captive)
2	Breather cap
3	Oil separator cartridge
4	Vent hose

### Procedure

Step	Activity
1	Release the four mounting bolts (1) on the breather cap (2).
2	Carefully lift the breather cap. If necessary, release the vent hose (4).
3	Remove the used oil separator cartridge and dispose of it according to local environmental regulations.
4	Wipe out the breather housing with a clean cleaning cloth. Make sure that dirt is not brought into the breather housing.
5	Insert a new oil separator cartridge.
6	Put on the breather cap and tighten the four mounting bolts (max. 4 Nm). If necessary, reattach the vent hose.

## 8.2.11 Check the screw connections

### Safety note



<b>NOTICE</b>	
	<ul style="list-style-type: none"> <li>▪ Only retighten loose screw connections. Screw connections can be secured with thread locking adhesive or tightened to a defined torque. Retightening tight screw connections can cause damage.</li> <li>▪ The adjusting screws on the injection system are secured with locking varnish and are not permitted to be tightened or adjusted.</li> <li>▪ Do not retighten the screws for attaching the cylinder head.</li> </ul>

### Procedure

Step	Activity
1	Check the condition of all screw connections and ensure that they are tight (for exceptions, see note).
2	Tighten any loose screw connections.

## 8.2.12 Drain the water separator

### Safety note

 <b>CAUTION</b>	
	<p><b>Danger of environmental damage from spilled fuel.</b></p> <p>When water is drained from the water separator, a small amount of fuel is drained as well.</p> <ul style="list-style-type: none"> <li>▪ Collect any escaped water/fuel mixture and dispose of it according to local environmental regulations.</li> </ul>

The main fuel filter is equipped with a water separator. An electronic water in fuel sensor signals when the maximum permissible water level is reached in the water separator (see section 9.2 *Diagnostic trouble codes in case of engine malfunctions*, page 131).

## Overview

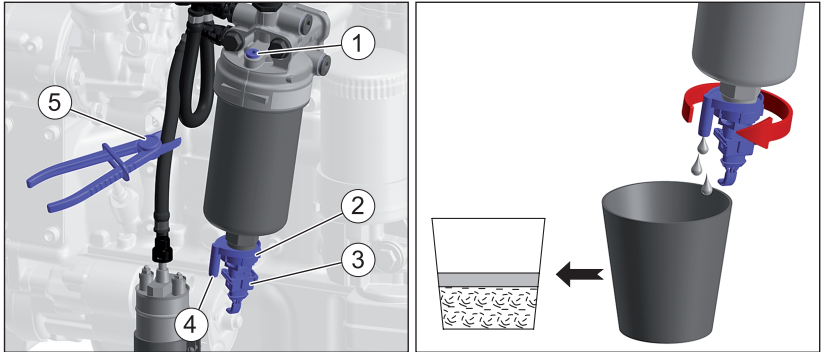











1	Vent screw
2	Drain screw with integrated water in fuel sensor
3	Plug of water in fuel sensor
4	Drain socket for extension hose
5	Hose clip (for a fuel tank positioned low)

## Procedure

Step	Activity
1	Place a suitable container under the drain socket (4) of the drain screw (2). <i>NOTE:</i> In inaccessible locations, an extension hose can be connected to the drain socket on the drain plug.
2	Open the drain screw (2) by hand and drain the water into the container.
3	If not enough liquid escapes, undo the additional vent screw (1). <i>NOTE:</i> If the fuel tank is lower than the main fuel filter, the fuel supply line must be disconnected with a hose clip (5). Otherwise fuel will run back into the fuel tank after the drain plug has been unscrewed.
4	As soon as fuel escapes, close the drain plug (2) and vent screw (1). <i>NOTE:</i> First water escapes then fuel. This can be seen by a clear separating line.
5	Disconnected fuel supply line is released again. Dispose of the water/fuel mixture in accordance with the local environmental regulations.

## 8.2.13 Changing the fuel prefilter

### Safety notes

 <b>DANGER</b>	
 	<p><b>Fire hazard from fuel</b></p> <p>Leaked or spilled fuel can ignite on hot engine parts and cause serious burn injuries.</p> <ul style="list-style-type: none"> <li>▪ Do not spill fuel.</li> <li>▪ No open flames when working on the fuel system.</li> <li>▪ Do not smoke.</li> </ul>
 <b>CAUTION</b>	
	<p><b>Danger of burns.</b></p> <p>There is a danger of burns when working on a hot engine.</p> <ul style="list-style-type: none"> <li>▪ Let the engine cool before maintenance.</li> </ul>
 <b>CAUTION</b>	
 	<p><b>Danger of injury.</b></p> <p>Repeated contact with diesel fuel can cause chapped and cracked skin.</p> <ul style="list-style-type: none"> <li>▪ Wear safety gloves.</li> <li>▪ If there is contact with the skin, thoroughly wash the affected areas of the skin with soap and water.</li> </ul>
 <b>CAUTION</b>	
	<p><b>Danger of environmental damage from spilled fuel.</b></p> <p>When the filter is removed, a small amount of fuel is drained as well.</p> <ul style="list-style-type: none"> <li>▪ Collect any escaping fuel and dispose of it according to local environmental regulations.</li> </ul>
<b>CAUTION</b>	
	<p><b>Dirt particles can damage the injection system.</b></p> <ul style="list-style-type: none"> <li>▪ Maintain clean conditions to ensure dirt does not enter the fuel line.</li> </ul>

## Overview

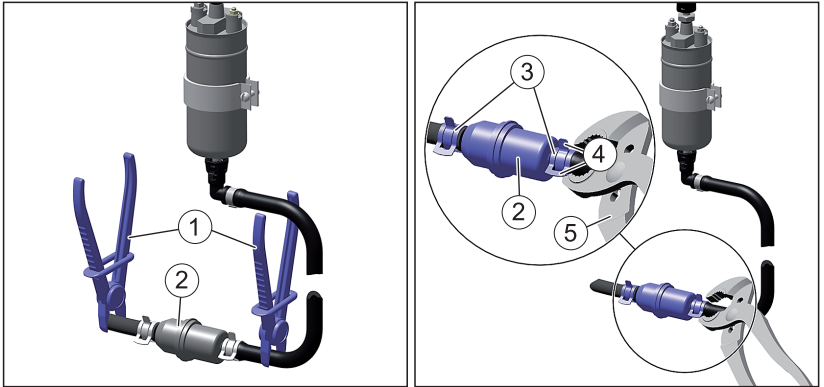











1	Hose clip
2	Fuel prefilter
3	Hose clamp
4	Tabs on the hose clamp
5	Pliers

Step	Activity
1	Block the fuel supply line upstream and downstream of the fuel prefilter (2) using hose clips (1).
2	Place a suitable container under the fuel prefilter to collect emerging fuel.
3	Release the hose clamps (3) and slide them to the back. To do so, squeeze the tabs (4) together with suitable pliers (5).
4	Unscrew the fuel prefilter (2) and dispose of it according to local environmental regulations.
5	Insert a new fuel prefilter. Observe the flow-through direction (arrows).
6	Slide the hose clamps to their original position.
7	Start the engine and perform a test run.
8	Check the filter and lines for tightness after a brief trial run.

## 8.2.14 Changing the main fuel filter

### Safety notes

 <b>DANGER</b>	
 	<p><b>Fire hazard from fuel</b></p> <p>Leaked or spilled fuel can ignite on hot engine parts and cause serious burn injuries.</p> <ul style="list-style-type: none"> <li>▪ Do not spill fuel.</li> <li>▪ No open flames when working on the fuel system.</li> <li>▪ Do not smoke.</li> </ul>
 <b>CAUTION</b>	
	<p><b>Danger of burns.</b></p> <p>There is a danger of burns when working on a hot engine.</p> <ul style="list-style-type: none"> <li>▪ Let the engine cool before maintenance.</li> </ul>
 <b>CAUTION</b>	
 	<p><b>Danger of injury.</b></p> <p>Repeated contact with diesel fuel can cause chapped and cracked skin.</p> <ul style="list-style-type: none"> <li>▪ Wear safety gloves.</li> <li>▪ If there is contact with the skin, thoroughly wash the affected areas of the skin with soap and water.</li> </ul>
 <b>CAUTION</b>	
	<p><b>Danger of environmental damage from spilled fuel.</b></p> <p>When the filter is removed, a small amount of fuel is drained as well.</p> <ul style="list-style-type: none"> <li>▪ Collect any escaping fuel and dispose of it according to local environmental regulations.</li> </ul>
<b>CAUTION</b>	
	<p><b>Dirt particles can damage the injection system.</b></p> <ul style="list-style-type: none"> <li>▪ Maintain clean conditions to ensure dirt does not enter the fuel line.</li> <li>▪ Only install fuel filters dry and do not prefill in order to avoid contamination.</li> </ul>



## Overview

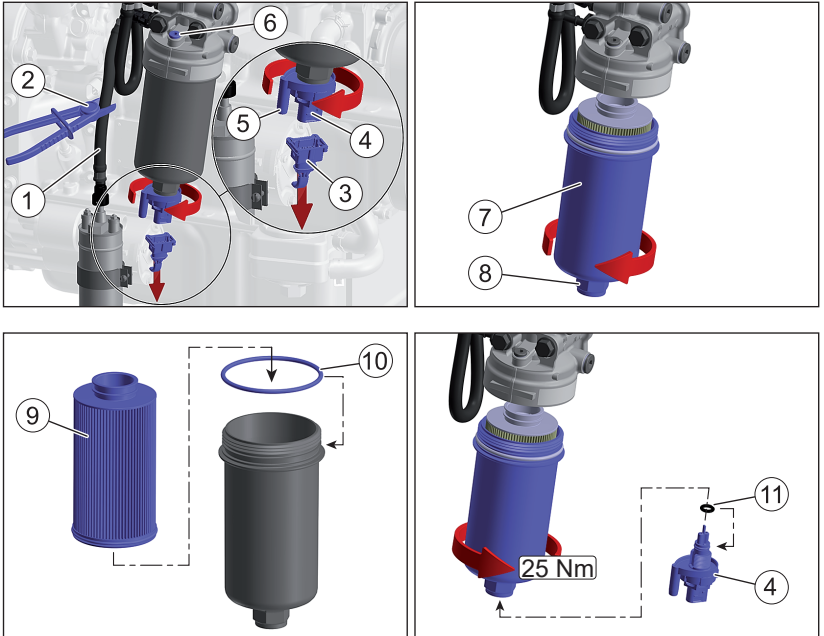

1	Fuel feed line
2	Hose clip
3	Connector to water in fuel sensor
4	Drain screw with integrated water in fuel sensor
5	Drain socket for extension hose
6	vent screw
7	Plastic screw cap
8	Hexagon for fitting a socket or ring wrench
9	filter insert
10	Sealing ring for plastic screw cap
11	Sealing ring to water in fuel sensor







## Procedure

Step	Activity
1	Block the fuel feed line (1) using the hose clip (2).
2	Disconnect the connector (3) to the water in fuel sensor.

Step	Activity
3	Place a suitable container under the filter (volume min. 1.5 liters) to collect escaping fuel. <i>NOTE:</i> In inaccessible locations, an extension hose can be connected to the drain socket on the drain plug.
4	First loosen the drain screw (4) and then the vent screw (6) and drain the fuel.
5	Then unscrew the drain plug (4) completely and put it aside.
6	Fit socket wrench or ring wrench onto hexagon (8) and unscrew plastic screw cap (7).
7	Dispose of the filter insert (9) and sealing ring (10) in accordance with local environmental regulations.
8	Lightly oil the new sealing ring and install it.
9	Insert the new filter insert into the screw cap.
10	Screw in the screw cap and tighten it to the specified tightening torque.
11	Dispose of the sealing ring (11) in accordance with local environmental regulations.
12	Lightly oil the new sealing ring and install it.
13	Screw in drain plug (4) and hand-tighten.
14	Install the connector to the water in fuel sensor.
15	Release the fuel feed line.
16	Bleed the fuel system (see chapter 6.6 <i>Venting the fuel system, page 61</i> ).
17	Start the engine and perform a test run.
18	After the test run, check the main fuel filter for leaks and tighten by hand if necessary.

## 8.2.15 Servicing the air filter (optional)

### Safety notes

 <b>CAUTION</b>	
 	<p><b>Danger of injury.</b></p> <p>When working with compressed air, foreign bodies may fly into your eyes.</p> <ul style="list-style-type: none"> <li>▪ Wear safety goggles.</li> <li>▪ Never direct the compressed air jet toward people or toward yourself.</li> </ul>
 <b>CAUTION</b>	
	<p><b>Danger of injury.</b></p> <p>When blowing out the filter cartridge, the ambient air becomes contaminated with dust.</p> <ul style="list-style-type: none"> <li>▪ This dust may contain harmful particles.</li> <li>▪ Wear a fine dust mask.</li> </ul>
<b>NOTICE</b>	
	<ul style="list-style-type: none"> <li>▪ Change the filter elements when there is oily or damp dirt contamination, cleaning is not possible.</li> <li>▪ Even minor damage in the areas of the sealing surface, filter paper, or filter cartridge makes reuse impossible.</li> <li>▪ The filter cartridge may not be washed out or beaten out.</li> <li>▪ The filter cartridge may be blown out only in exceptional cases. The pressure must not exceed 5 bar.</li> </ul>

### Overview

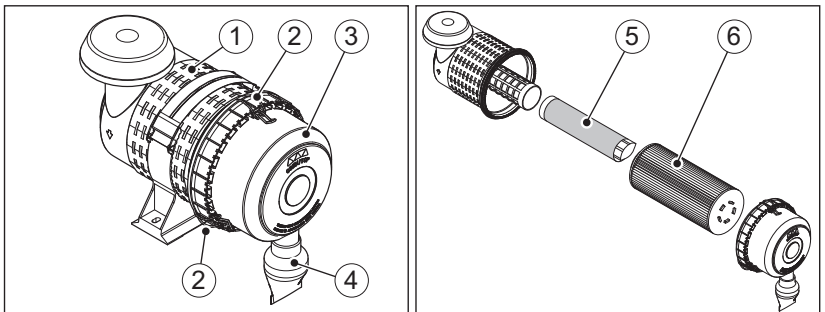

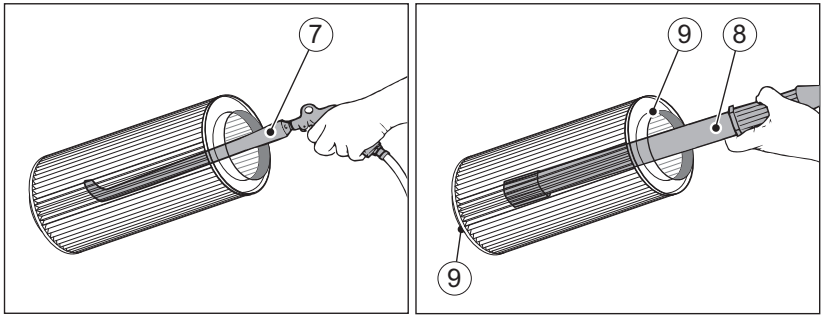

1	Air filter housing
2	Retaining clips
3	Air filter cover
4	Dust discharge valve
5	Secondary filter
6	Primary filter
7	Air gun with extension tube (tip bent)
8	Lamp
9	Sealing surfaces

### Replacing the primary/secondary filters

Step	Activity
1	Open the retaining clips (2) and remove the air filter cover (3).
2	Pull out the primary filter (6) and either replace (recommended) or clean (see below). The primary filter must be replaced every 12 months at the latest; cleaning is no longer possible after this time.
3	Remove dirt adhering to the inside of the air filter housing (1), air filter cover (3), and dust discharge valve (4).
4	Pull out and check the secondary filter (5), replace if required. The secondary filter can not be cleaned. The secondary filter must be replaced after every fifth replacement of the primary filter, though no later than every two years.
5	Carefully insert new filter elements.
6	Place the air filter cover on the air filter housing and lock all retaining clips, making sure that the dust discharge valve points vertically downwards.

## Cleaning the primary filter







Step	Activity
1	Blow out the primary filter (6) with dry compressed air from the inside to the outside until dust no longer emerges. Use an air gun with an extension tube (7) with the end bent by approx. 90°. The end of the extension tube must not touch the filter paper.
2	Check the sealing surfaces (9) of the filter cartridge for damage.
3	Check the filter cartridge for tears or other damage in the filter paper by holding it against the light at a slant or shining light from a lamp (8) through it. In case of doubt, always replace the primary filter. <i>NOTE:</i> The primary filter may only be cleaned once, then it must be replaced.

### 8.2.16 Change the coolant

This chapter contains the following subchapters:

- **Draining the cooling system**
- **Rinsing the cooling system**
- **Filling the cooling system**

#### Safety notes

 <b>CAUTION</b>	
 	<p><b>Danger of scalding and risk of environmental damage due to hot coolant.</b></p> <ul style="list-style-type: none"> <li>▪ Excessive coolant is blown off from the sealing cap on the expansion tank. After topping up the cooling system never move parts of your body or face close to the sealing cap.</li> <li>▪ Never top up coolant above the MAX - mark on the expansion tank.</li> <li>▪ Never stop escaping coolant with your bare hands.</li> </ul>
 <b>CAUTION</b>	
 	<p><b>Danger of burns.</b></p> <p>There is a danger of burns when working on a hot cooling system. The cooling system is pressurized when the engine is hot.</p> <ul style="list-style-type: none"> <li>▪ Let the engine cool.</li> <li>▪ Wear safety gloves.</li> </ul>



## CAUTION



### Danger of environmental damage from spilled coolant.

Coolant is water-polluting.

- Do not allow them to enter the ground water, water bodies, or sewage system.
- Collect the coolant and dispose of it according to local environmental regulations.

## Overview

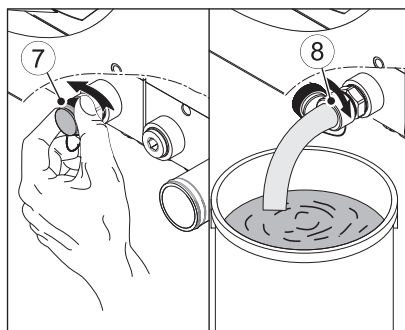
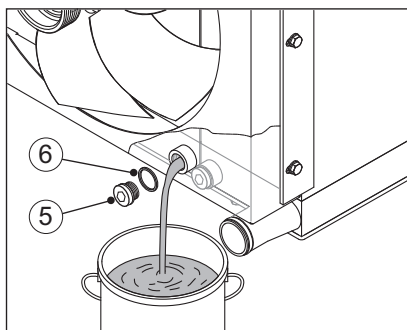
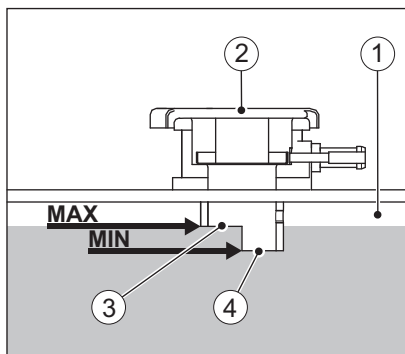
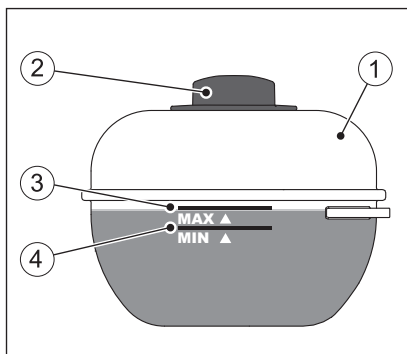

1	Expansion tank for coolant
2	Sealing cap
3	<b>MAX</b> - Maximum coolant level
4	<b>MIN</b> - Minimum coolant level
5	Drain screw on engine cooler
6	Seal ring
7	Screw plug for drain valve on engine cooler

8	Drain hose
---	------------

### Draining the cooling system

Step	Activity
1	Provide a container to collect the used coolant. The container must be large enough to hold the entire amount of oil. For the amount of coolant, see section 4.1 <i>Engine information and filling quantities</i> , page 21.
2	Open the sealing cap (2) of the expansion tank (1).

#### Model with drain plug

3	Unscrew the drain plug (5) and drain the coolant into the container.
4	Screw in the drain plug (5) with a new sealing ring (6) and tighten. Tightening torque: 50 Nm.

#### Model with drain valve

3	Remove the screw plug (7). Then place the drain hose (8) on the drain valve and screw tight by hand. <ul style="list-style-type: none"> <li>▪ When tightening, the drain valve opens allowing the coolant to drain.</li> </ul>
4	Remove the drain hose and reattach the screw plug.

### Rinsing the cooling system

The cooling system only needs to be rinsed if contaminants are detected in the coolant.

#### Contaminants can include:

- Engine oil due to a defective cylinder head gasket (discoloration of the coolant).
- Corrosion due to used or unsuitable coolant (discoloration of the coolant).
- Foreign bodies due to:
  - Insufficient cleaning during repairs to the cooling system
  - Reuse of drained coolant

As contaminants in the coolant could be an indication of a larger problem, we recommend having the rinsing of the cooling system carried out by trained specialist personnel.

### Filling the cooling system

See section 6.5 *Filling the cooling system*, page 59



## 8.2.17 Draining the charge air cooler

### Introduction

This maintenance work only pertains to engine specifications **TI**, **TIC** and **TICD**.

Over the course of time and depending on the engine utilization, condensate and engine oil collect in the charge air cooler. Drain this mixture consisting of condensate and oil as per the maintenance schedule and dispose of it according to local environmental regulations.

### Safety note

 <b>CAUTION</b>	
	<p><b>Danger of burns.</b></p> <p>There is a danger of burns when working on a hot engine.</p> <ul style="list-style-type: none"> <li>Let the engine cool before maintenance.</li> </ul>

### Overview

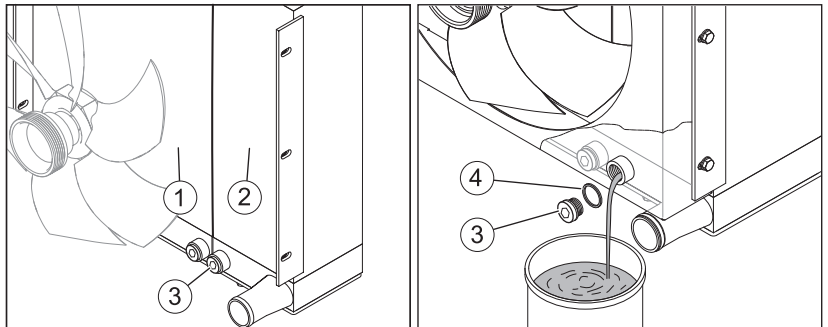

1	Engine radiator
2	Charge air cooler
3	Drain screw on charge air cooler
4	Seal ring

### Procedure

Step	Activity
1	Have a container ready for capturing the liquid.
2	Unscrew the drain plug (3) and let the liquid flow into the container.
3	Screw in the drain plug (3) with a new gasket (4) and tighten. Tightening torque: 50 Nm.



Step	Activity
4	Dispose of the drained mixture consisting of condensate and oil according to local environmental regulations.

### 8.2.18 Resetting the service interval indicator

After completion of service work, reset the service interval indicator. The counter alerts you when the next major service is due.

#### Procedure

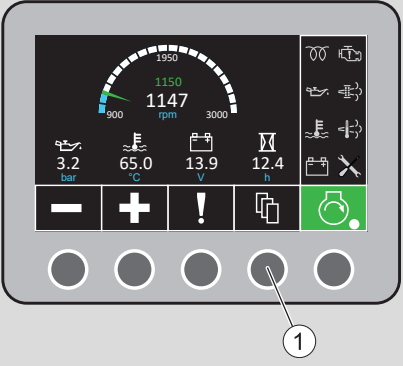
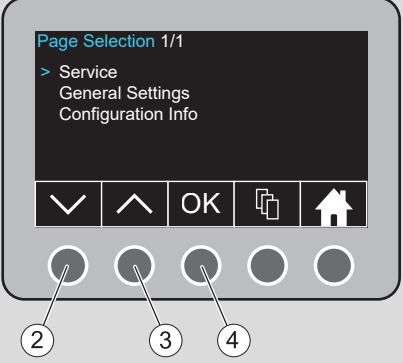
Step	Activity	Figure
1	In the <b>main menu</b> , press the button for menu selection (1) repeatedly until the <b>Page Selection</b> menu appears.	<p><b>Main menu</b></p> 
2	Using buttons (2 or 3), select the <b>Service</b> menu and confirm with OK (button 4).	<p><b>Page Selection</b></p> 

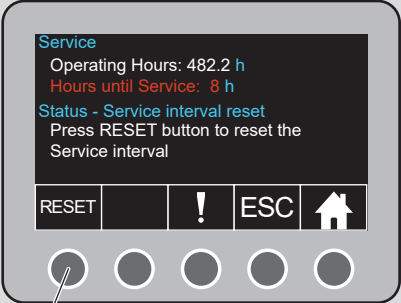
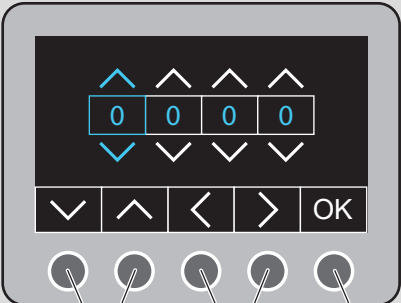
Step	Activity	Figure
3	<p>To reset the service interval indicator, press button (5).</p>	<p><b>Service</b></p>  <p>The screen displays the following information: "Service", "Operating Hours: 482.2 h", "Hours until Service: 8 h", "Status - Service interval reset", and "Press RESET button to reset the Service interval". Below the text is a control panel with buttons labeled "RESET", "!", "ESC", and a home icon. Below the control panel are five circular buttons, with the first one on the left circled in red and labeled with the number 5.</p>
4	<p>The display changes to the password entry page. Now enter the 4-digit password. The factory password is <b>2354</b>. Begin with the entry as follows:</p> <ul style="list-style-type: none"> <li>▪ Select the desired time with the buttons (6).</li> <li>▪ Select the number pad with the buttons (7).</li> <li>▪ Then confirm the password with OK (button 8).</li> </ul> <p><i>Note:</i> The password can be changed by a Hatz service partner if desired using the diagnosis software HDS<sup>2</sup>.</p>	<p><b>Password</b></p>  <p>The screen displays a password entry interface with four input fields, each containing the digit "0". Above each field are up and down arrow buttons. Below the input fields are left and right arrow buttons, and an "OK" button. Below the control panel are five circular buttons, with the first two circled in red and labeled with the numbers 6 and 7, and the last one circled in red and labeled with the number 8.</p>

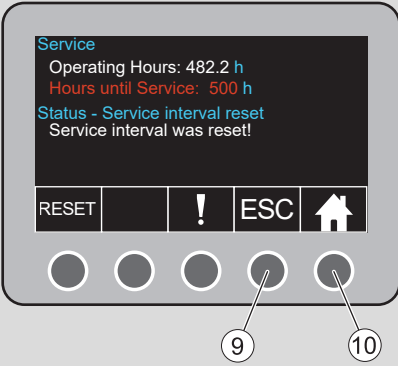
Step	Activity	Figure
5	<p>The service interval indicator is reset. The hours counter indicates the number of operating hours remaining until the next major service.</p> <p>Pos. 9 = Return to Page Selection.</p> <p>Pos. 10 = Home (return to main page).</p>	<p><b>Service</b></p> 

### NOTICE



#### If a Hatz Smart Panel is not used:

Comply with the instructions in the documentation for the **complete machine**.

## 9 Faults

### 9.1 Troubleshooting

#### General troubleshooting notes

If the cases listed below have been worked through but the fault continues to persist, please contact your nearest **Hatz service station**.

#### The engine malfunction indicator lights up on the HATZ Smart Panel.

Possible causes	Remedy	Section
Various errors in different assemblies.	Identify and rectify the fault on the basis of the diagnostic trouble code table.	<i>9.2 Diagnostic trouble codes in case of engine malfunctions, page 131</i>

#### The engine does not start or does not start immediately, but can be turned with the starter.

Possible causes	Remedy	Chapter
Hydraulic load too high (especially with multiple hydraulic pumps).	Reduce the hydraulic load – if possible.	
Insufficient compression.	Contact HATZ Service.	
Cylinder and/or piston ring wear.	Contact HATZ Service.	
<b>Fuel supply is interrupted:</b>		
The tank ran out of fuel during operation.	Add fuel.	<i>7.6 Refueling, page 72</i>
Electrical fuel pump is not working.	Check the cabling.	
Fuel prefilter is clogged.	Change the fuel prefilter.	<i>8.2.13 Changing the fuel prefilter, page 114</i>
Main fuel filter is clogged.	Change the main fuel filter.	<i>8.2.14 Changing the main fuel filter, page 116</i>

**At low temperatures (engine does not start)**

Possible causes	Remedy	Chapter
Oil is too viscous and causes a too low starter speed.	Change the engine oil and oil filter. Add engine oil with a suitable viscosity class.	8.2.6 <i>Changing the engine oil and oil filter, page 93</i>
Insufficiently charged battery.	Check the battery and contact the service center if necessary.	3.2.4 <i>Electrical equipment, page 18</i>
Machine is not uncoupled.	If possible, separate the engine from the machine by uncoupling it.	

**The starter does not switch on and the engine does not turn.**

Possible causes	Remedy	Chapter
<b>Irregularities in the electrical equipment:</b>		
Battery and/or other cable connections are incorrectly connected.	Check the electrical equipment and its components or contact Hatz service.	3.2.4 <i>Electrical equipment, page 18</i>
Cable connections are loose and/or oxidized.		
Battery is defective and/or not loaded.		
Defective starter.		
Defective relay, monitoring elements etc.		

**Engine switches off spontaneously during operation.**

Possible causes	Remedy	Section
The tank ran out of fuel during operation.	Fill with fuel.	7.6 <i>Refueling, page 72</i>
Mechanical defects.	Contact HATZ service.	
Electrical defects.	Check the wiring or contact HATZ service.	
Engine malfunction (engine malfunction indicator lights up)	Identify and rectify the fault on the basis of the diagnostic trouble code table.	9.2 <i>Diagnostic trouble codes in case of engine malfunctions, page 131</i>

**The engine loses power and speed.**

Possible causes	Remedy	Section
The engine is running in emergency mode due to a malfunction (engine malfunction indicator is lit).	Identify and rectify the fault on the basis of the diagnostic trouble code table.	<i>9.2 Diagnostic trouble codes in case of engine malfunctions, page 131</i>
	If the engine malfunction persists, contact a HATZ service center immediately.	
The tank ran out of fuel during operation.	Add fuel.	<i>7.6 Refueling, page 72</i>

**The engine loses power and speed, and black smoke emerges from the exhaust.**

Possible causes	Remedy	Chapter
Dirty air filter unit.	Check the degree of dirt contamination of the air filter, and clean or renew it if necessary.	<i>8.2.15 Servicing the air filter (optional), page 119</i>
Turbocharger faulty or leaking hoses.	Check hoses or contact HATZ Service.	
Injector not fully functional.	Contact HATZ Service.	

**Engine becomes very hot. The engine temperature indicator lights up.**

Possible causes	Remedy	Chapter
Contamination in the entire area of the cooling air guides.	Clean the cooling air area.	
Cooler fins dirty, or cooler blocked.	Clean the cooler fins, ensure air flow through cooler is not hindered.	<i>8.2.7 Clean the radiator fins, page 99</i> <i>8.2.5 Check the cooling system, page 90</i>
Thermostat or water pump defective.	Contact HATZ service.	
Coolant level too low.	Check the cooling system.	<i>8.2.5 Check the cooling system, page 90</i>

## 9.2 Diagnostic trouble codes in case of engine malfunctions

### Overview

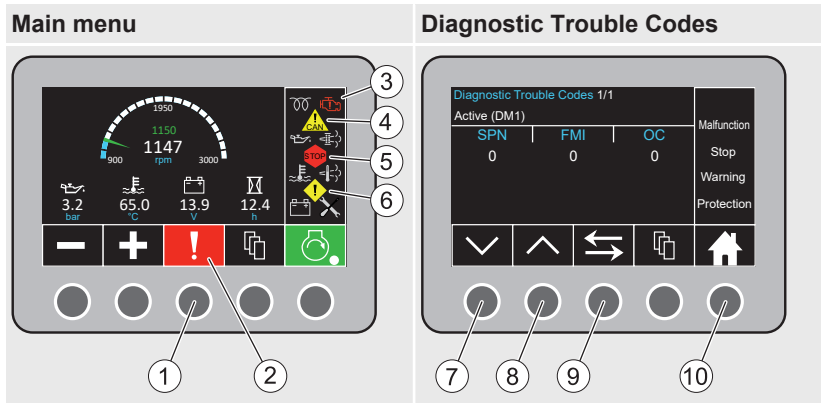

1	Button for calling up the diagnostic trouble codes
2	Symbol <b>Diagnostic trouble codes</b> flashes
3	Symbol <b>Engine malfunction</b> is lit
4	Symbol <b>Fault lamp CAN</b> flashes depending on error
5	Symbol <b>Fault lamp STOP</b> flashes depending on error
6	Symbol <b>Fault lamp warning</b> flashes depending on error
7	Page <b>forward</b> (in case of a long list)
8	Page <b>back</b> (in case of a long list)
9	Change between <b>active</b> and <b>historical</b> diagnostic trouble code list
10	Home (back to main menu)

When malfunctions occur, the engine malfunction indicator lights up and the symbol for the diagnostic trouble codes flashes. One or more fault lamps (4-6) also flash. The indicator on the display automatically changes to the **Diagnostic Trouble Codes** menu. The diagnostic trouble codes are listed here.

#### Error description:

SPN	=	error signal
FMI	=	error type
OC	=	error frequency







**Example:**

SPN	190	The determining parameter is the crankshaft speed
FMI	9	The error that occurred is: sensor signal not plausible
OC	12	This error occurred 12 times

A list of all diagnostic trouble codes can be viewed at [www.hatz.com/docu](http://www.hatz.com/docu). If the listed malfunction cases have been worked through but the malfunction continues to persist, please contact your nearest **HATZ service center**.

**9.3 Start support**

**Safety notes**

 <b>DANGER</b>	
	<p><b>Danger of explosion due to the generation of sparks.</b></p> <p>When carrying out the start support, a battery can generate an explosive gas mixture.</p> <ul style="list-style-type: none"> <li>▪ Avoid fire, sparks, open flames and smoking.</li> <li>▪ Avoid short-circuits.</li> <li>▪ Only connect battery terminals with identical polarity (see <i>Overview</i> section).</li> <li>▪ Always observe the sequence described for connecting and disconnecting the start support cable.</li> <li>▪ Do not place tools or other metal objects on the battery.</li> </ul>
 <b>WARNING</b>	
  	<p><b>Danger of chemical burns.</b></p> <p>Battery acid is highly corrosive and can cause eye and skin injuries.</p> <ul style="list-style-type: none"> <li>▪ Wear safety goggles and safety gloves.</li> </ul>





## WARNING

### Danger of injury or property damage due to incorrectly carried out start support.

If the instructions for the start support are not adhered to precisely, there is a danger of explosion due to the generation of sparks as well as a danger of chemical burns due to leaking battery acid.

- Observe the attached information and warning signs (see section 3.3 *Labels*, page 19)
- Do not use a charger unit with Boost function. Electrical components could be destroyed due to overvoltage.
- Use a suitable start support cable with insulated cable pliers.

Required line cross-section:

- 12 volts min. 50 mm<sup>2</sup>
- 24 volts min. 35 mm<sup>2</sup>
- Never swap the positive (+) and negative (-) battery terminals (danger of short circuit).
- Make sure that the start support cables are laid in such a way that they cannot be damaged by rotating parts or become disconnected from the battery terminals.
- A discharged battery and current emitting battery must have the same voltage (12 volts). The battery capacity should be about the same.
- A discharged battery can freeze even at temperatures just a few degrees below zero. If the battery is frozen or thawed, do not carry out a start support. Replace the battery.



### Overview – 12 volt model

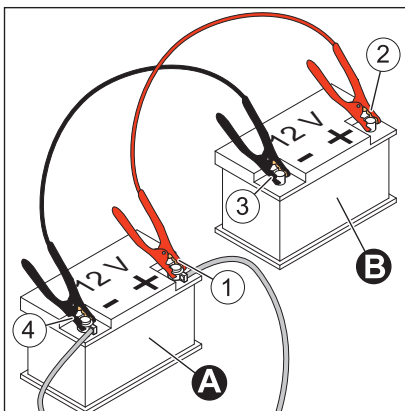

<b>Battery</b>	
A	Discharged battery
B	Current emitting battery
<b>Red start support cable (positive (+) terminal)</b>	
1	Clamp pliers on the positive (+) terminal of the discharged battery
2	Clamp pliers on the positive (+) terminal of the current emitting battery
<b>Black start support cable (negative (-) terminal)</b>	
3	Clamp pliers on the negative (-) terminal of the current emitting battery
4	Clamp pliers on the negative (-) terminal of the discharged battery

#### Procedure – 12 volt model

<b>Step</b>	<b>Activity</b>
1	A second battery (12 volts) or an external device with a 12 volt system can be used for the start support. See also the instructions in the documentation for the external device.
2	Turn the starting key to position "0" on both machines.
3	Connect the batteries using the clamp pliers of the start support cable in the sequence 1–2–3–4 (see <i>Overview – 12 volt model</i> ).
4	<b>Do not start</b> the external device.
5	Start the machine with the discharged battery.
6	Let the engine run for several minutes.
7	Disconnect the start support cable in the sequence 4–3–2–1.

## Overview – 24 volt model

**NOTICE**

The 24 volt model is supplied with two 12 volt batteries that are connected in series with a connection cable (C).

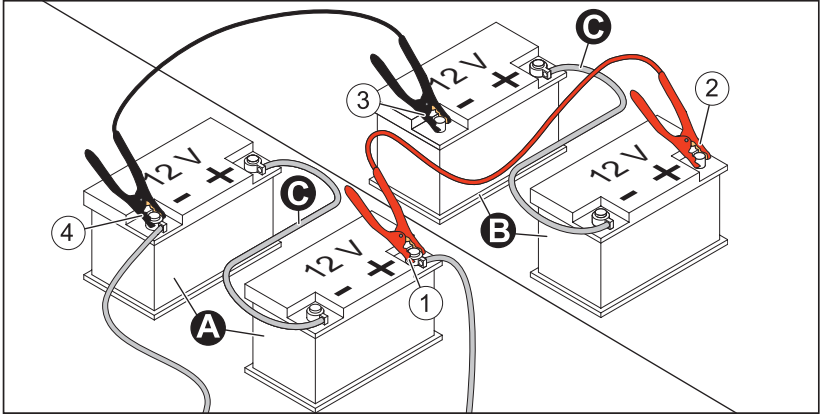
**Batterys**

A	Discharged batteries
B	Current emitting batteries
C	Connection cable between the batteries

**Red start support cable (positive (+) terminal)**

1	Clamp pliers on the positive (+) terminal of the discharged battery
2	Clamp pliers on the positive (+) terminal of the current emitting battery

**Black start support cable (negative (-) terminal)**

3	Clamp pliers on the negative (-) terminal of the current emitting battery
4	Clamp pliers on the negative (-) terminal of the discharged battery

**Procedure – 24 volt model**

Step	Activity
1	Either two batteries (12 volts) with connection cable (C) can be used for start support in accordance with <i>Overview – 24 volt model</i> or an external device with a 24 volt system. See also the instructions in the documentation for the external device.
2	Turn the starting key to position "0" on both machines.
3	Connect the batteries using the clamp pliers of the start support cable in the sequence 1–2–3–4 (see <i>Overview – 24 volt model</i> ).
4	<b>Do not start</b> the external device.
5	Start the machine with the discharged battery.
6	Let the engine run for several minutes.
7	Disconnect the start support cable in the sequence 4–3–2–1.

## 10 Storage and disposal

### 10.1 Storing the machine

#### Safety notes



#### DANGER



#### Danger to life from inhaling exhaust gases.

Toxic engine exhaust gases can lead to loss of consciousness, and even death, in closed-off and poorly ventilated rooms.

- Never operate the machine in closed-off or poorly ventilated rooms.
- Do not breathe in the exhaust gases.



#### DANGER



#### Fire hazard from fuel.

Leaked or spilled fuel can ignite on hot engine parts and cause serious burn injuries.

- Only refuel when the engine is switched off and has cooled down.
- Never refuel in the vicinity of open flames or sparks that can cause ignition.
- Do not smoke.
- Do not spill fuel.



#### CAUTION



#### Danger of environmental damage from spilled fuel.

Do not overfill the fuel tank and do not spill fuel.

- Collect any leaking fuel and dispose of it according to local environmental regulations.



#### CAUTION



#### Danger of burns.

There is a danger of burns when working on a hot cooling system. The cooling system is pressurized when the engine is hot.

- Let the engine cool.
- Wear safety gloves.

**NOTICE****Comply with the safety chapter!**

Follow the basic safety instructions in chapter 3 *Safety*, page 7.

**Storing the machine for a lengthy period**

Take the following measures if you intend to take the machine out of service for a lengthy period (3-12 months):

Step	Activity
1	Drain the fuel tank until it is nearly empty and fill with FAME*-free fuel. Operate the engine for a few minutes so that only FAME-free fuel is still in the fuel system.
2	Change the engine oil and oil filter (see chapter 8.2.6 <i>Changing the engine oil and oil filter</i> , page 93).
3	Replace the fuel prefilter and the main fuel filter (see section 8.2.13 <i>Changing the fuel prefilter</i> , page 114 and 8.2.14 <i>Changing the main fuel filter</i> , page 116).
4	Let the machine cool down.
5	Check the coolant level and concentration. Refill coolant if necessary (see section 8.2.5 <i>Check the cooling system</i> , page 90). If the concentration is too low, replace the coolant (see section 8.2.16 <i>Change the coolant</i> , page 121).
6	Remove the battery in accordance with the Operator's Manual for the machine and store at ambient temperature. Comply with the local regulations as well as the regulations of the battery manufacturer for the storage of batteries.
7	Close and seal all engine openings (air intake openings, air outlet openings and the exhaust gas opening) so that no foreign bodies can enter, but a small amount of air can still be exchanged. This avoids condensation.
8	After the machine has cooled down, cover it to protect it against contamination, and store it in a dry and clean place.

\*FAME = Fatty Acid Methyl Ester

**Ambient conditions during storage**

- Max. permissible storage temperature: -25 °C to +60 °C
- Max. permissible humidity: 70%
- Protect the engine from direct sunlight

## Recommissioning

Step	Activity
1	Remove all covers.
2	Check the cables, hoses and lines for cracks and leak tightness.
3	Check the engine oil level.
4	Check the coolant level.
5	Install the battery in accordance with the Operator's Manual for the machine.

The brand new engine can normally be stored for up to 12 months. The protection lasts up to approx. 6 months at very high humidity and in sea air.

For storage periods of more than 12 months, please contact the nearest **HATZ Service**.

## 10.2 Disposing of the machine

### Disposal information

Dispose of the machine (including machine parts, engine oil, coolant, and fuel) according to the local disposal regulations and the environmental laws in the country of use.

Because of the danger of possible environmental damage, only permit an approved specialist company to dispose of the machine.

### NOTICE



When the machine has reached the end of its lifecycle, ensure that it is disposed of safely and properly, especially parts and substances that can be dangerous to the environment. These also include fuel, coolant, lubricants, plastics, and batteries (if present).

- Do not dispose of the battery with the household trash.
- Dispose of the battery at a collection point for possible recycling.

# 11 Declaration of incorporation

## Extended Declaration of Incorporation EC Machinery Directive 2006/42/EC

The manufacturer: **Motorenfabrik Hatz GmbH & Co.KG**  
**Ernst-Hatz-Straße 16**  
**D-94099 Ruhstorf a. d. Rott, Germany**

herewith declares that the incomplete machine: product designation: **Hatz diesel engine**  
 type designation and beginning with consecutive serial no.:

**3H50T = 17811; 3H50TI = 16321; 3H50TIC = 13521; 3H50TICD = 16411;**

**4H50TI = 16121; 4H50TIC = 13621; 4H50TICD = 16511;**

**4H50N = 14711; 4H50NO = 19210**

is in compliance with the following basic safety and health protection requirements as per Annex I of the Machinery Directive named above.

- General principles no. 1

- No. 1.1.2., 1.1.3., 1.1.5., 1.2.1., 1.2.2., 1.2.3., 1.2.4.1., 1.2.4.2., 1.3.1., 1.3.2., 1.3.3., 1.3.4., 1.3.7., 1.4.1., 1.5.1., 1.5.2., 1.5.3., 1.5.8., 1.5.9., 1.5.10., 1.5.11., 1.6.1., 1.6.2., 1.6.4., 1.7.1., 1.7.2

All relevant basic safety and health protection requirements up to the interfaces described in the following documents:

- Diesel Engine Manual
- Attached data sheets
- Attached technical documentation

have been met.

The following standards (or parts thereof) were applied:

- EN 1679-1: 092011                      - EN ISO 12100: 032011                      - EN ISO 13857: 042020  
 - EN 60204-1:062019

The Diesel Engine Manual is included with the incomplete machine and the Installation Instructions were made available to the customer electronically with the order confirmation.

The special technical documentation was created as per Annex VII B of Machinery Directive 2006/42/EC.

I will forward the special technical documentation specified above to the appropriate authority if necessary.

The special technical documentation specified above can be requested from:

Wolfgang Krautloher; contact the manufacturer for the address

Commissioning of the equipment is prohibited until it has been established, if possible, that the machine into which the above machine is to be installed meets the specifications of the Machinery Directive.

20/02/2023

Date



Friedrich Peter  
 Head of Type Series, Water-  
 Cooled Engines



Dr.-Ing. Simon Thierfelder  
 Chief Technical Officer - CTO



## 12 Declaration of the manufacturer

The following "Manufacturer's declaration of compliance with regulation (EU) 2016/1628" only applies to engines with an engine family designation in accordance with chapter 1.5 (see next two pages).

The corresponding engine family designation is noted on the engine type plate (see chapter 4.2 *Engine type plate*, page 25).

### CO<sub>2</sub> emissions\*

Engine family designation	CO <sub>2</sub> g/kWh	Test cycle	Parent engine	Speed
3/4H50TICD-cs	855.39	NRSC-D2	3H50TICD	3000
3/4H50TICD-vs	736.59	NRSC-C1	3H50TICD-HT	2800
	787.30	NRTC	3H50TICD-HT	2800
H50TIC-IWA-cs	704.91	NRSC-D2	4H50TIC	1,800
H50TIC-IWA-vs	751.80	NRSC-C1	3H50TIC	2800
H50TIC-IWP-vs	734.02	NRSC-E3	4H50TIC	2800

\*According to EU Regulation 2016/1628, Article 43 Paragraph (4)

## Declaration by manufacturer on compliance with Regulation (EU) 2016/1628

The undersigned: Manfred Wührmüller, Head of Quality Management GMQ

Hereby declares that the following engine type/engine family (\*) complies in all respects with the requirements of Regulation (EU) 2016/1628 of the European Parliament and of the Council <sup>(1)</sup>, Commission Delegated Regulation (EU) 2017/654 <sup>(2)</sup>, Commission Delegated Regulation (EU) 2017/655 <sup>(3)</sup> and Commission Implementing Regulation (EU) 2017/656 <sup>(4)</sup> and does not use any defeat strategy.

All emission control strategies comply, where applicable, with the requirements for Base Emission Control Strategy (BECS) and Auxiliary Emission Control Strategy (AECS) set-out in section 2 of Annex IV to Delegated Regulation (EU) 2017/654, and have been disclosed in accordance with that Annex and with Annex I to Implementing Regulation (EU) 2017/656.

- 1.1. Make (trade name(s) of manufacturer): **Hatz**
- 1.2. Commercial name(s) (if applicable): **Hatz-Diesel**
- 1.3. Company name and address of manufacturer:  
**Motorenfabrik Hatz GmbH & Co. KG, Ernst-Hatz-Str. 16, 94099 Ruhstorf a.d. Rott**
- 1.4. Name and address of manufacturer's authorised representative (if any): –
- 1.5. Engine type designation/ engine family designation/ FT (\*): **3/4H50TICD-cs, 3/4H50TICD-vs**

(Place) (Date):

*Ruhstorf a.d. R. 04.07.18*  

- 
- <sup>(1)</sup> Regulation (EU) 2016/1628 of the European Parliament and of the Council of 14 September 2016 on requirements relating to gaseous and particulate pollutant emission limits and type-approval for internal combustion engines for non-road mobile machinery, amending Regulations (EU) No 1024/2012 and (EU) No 167/2013, and amending and repealing Directive 97/68/EC (OJ L 252, 16.9.2016, p. 53).
  - <sup>(2)</sup> Commission Delegated Regulation (EU) 2017/654 of 19 December 2016 supplementing Regulation (EU) 2016/1628 of the European Parliament and of the Council with regard to technical and general requirements relating to emission limits and type-approval for internal combustion engines for non-road mobile machinery (OJ L 102, 13.4.2017, p. 1).
  - <sup>(3)</sup> Commission Delegated Regulation (EU) 2017/655 of 19 December 2016 supplementing Regulation (EU) 2016/1628 of the European Parliament and of the Council with regard to monitoring of gaseous pollutant emissions from in-service internal combustion engines installed in non-road mobile machinery (OJ L 102, 13.4.2017, p. 334).
  - <sup>(4)</sup> Commission Implementing Regulation (EU) 2017/656 of 19 December 2016 laying down the administrative requirements relating to emission limits and type-approval of internal combustion engines for non-road mobile machinery in accordance with Regulation (EU) 2016/1628 of the European Parliament and of the Council (OJ L 102, 13.4.2017, p. 364).
  - <sup>(5)</sup> Regulation (EU) No 910/2014 of the European Parliament and of the Council of 23 July 2014 on electronic identification and trust services for electronic transactions in the internal market and repealing Directive 1999/93/EC (OJ L 257, 28.8.2014, p. 73).

## Declaration of the manufacturer on compliance with Regulation (EU) 2016/1628

The signees: Jakob Reif and Dr. Andreas Stadler

herewith declare that the following engine type/engine family (\*) complies in all respects with the requirements of Regulation (EU) 2016/1628 of the European Parliament and of the Council (1), Commission Delegated Regulation (EU) 2017/654 (2), Commission Delegated Regulation (EU) 2017/655 (3) and Commission Implementing Regulation 2017/656 (4) and does not use defeat devices.

All emission reduction strategies, where applicable, comply with the requirements of the standard emission reduction strategy and the supplementary emission reduction strategy set out in Section 2 of Annex IV to Delegated Regulation (EU) 2017/654 on technical and general requirements and have been disclosed in accordance with that Annex and with Annex I to Implementing Regulation (EU) 2017/656 on administrative requirements.

- 1.1. Trademark (manufacturer trademark(s)): **Hatz**
- 1.2. Trade name(s) (if any): **Hatz-Diesel**
- 1.3. Manufacturer company name and address:  
**Motorenfabrik Hatz GmbH & Co. KG, Ernst-Hatz-Str. 16, 94099 Ruhstorf a.d.Rott**
- 1.4. If applicable, name and address of the authorized representative of the manufacturer: ---
- 1.5. ~~Engine type designation~~/engine family designation/ET (\*) **H50TIC-IWA-cs, H50TIC-IWA-vs, H50TIC\_IWP-vs**

Ruhstorf 15. 11. 22, J. Reif.  
Place, date, Jakob Reif, Head of Quality Assurance

Ruhstorf 16. 11. 22, A. Stadler  
Place, date, Dr. Andreas Stadler, Head of Thermodynamics

Signature (or visual representation of an "advanced electronic signature" in compliance with Directive (EU) No. 910/2014 of the European Parliament and of the Council (5), including the signature test data):

(\*) ~~Cross out choices that are unused or indicate only the choices used.~~

- (1) Regulation (EU) 2016/1628 of the European Parliament and of the Council of 14 September 2016 on the requirements relating to emission limit values for gaseous and particulate pollutants and the type-approval of internal combustion engines to be installed in non-road mobile machinery, amending Regulations (EU) No 1024/2012 and (EU) No 167/2013, and amending and repealing Directive 97/68/EC (OJ L 252, 16.09.2016, p. 53).
- (2) Commission Delegated Regulation (EU) 2017/654 of 19 December 2016 supplementing Regulation (EU) 2016/1628 of the European Parliament and of the Council on technical and general requirements concerning emission limits and type-approval of internal combustion engines to be installed in non-road mobile machinery (OJ L 102, 13.04.2017, p. 1).
- (3) Commission Delegated Regulation (EU) 2017/655 of 19 December 2016 supplementing Regulation (EU) 2016/1628 of the European Parliament and of the Council on the monitoring of emissions of gaseous pollutants from in-service internal combustion engines to non-road mobile machinery (OJ L 102, 13.04.2017, p. 334).
- (4) Commission Implementing Regulation (EU) 2017/656 of 19 December 2016 laying down the administrative requirements for emission limit values and type-approvals for internal combustion engines to be installed in non-road mobile machinery pursuant to Regulation (EU) 2016/1628 of the European Parliament and of the Council (OJ L 102, 13.04.2017, p. 364).
- (5) Regulation (EU) No 910/2014 of the European Parliament and of the Council of 23 July 2014 on electronic identification and trust services for electronic transactions in the internal market and repealing Directive 1999/93/EC (OJ L 257, 28.08.2014, p. 73).

**Motorenfabrik Hatz GmbH & Co. KG**

Ernst-Hatz-Str. 16

94099 Ruhstorf a. d. Rott

Deutschland

Tel. +49 8531 319-0

Fax. +49 8531 319-418

marketing@hatz-diesel.de

www.hatz-diesel.com



**CREATING POWER SOLUTIONS.**

**0000 436 004 07 - 12.2023**

Printed in Germany

EN